

PJM Manual 14H:

New Service Requests Cycle Process

Revision: 03

Effective Date: September 25, 2025

Prepared By
Interconnection Projects Department

PJM © 2025



Table of Contents

Table of Exhibits	7
Approval	10
Current Revision	11
Introduction	12
About This Manual	12
Section 1: New Service Requests Process Overview and Determining Customer Type.....	15
1.1 PJM New Service Request Process Overview	15
1.2 New Service Request Customer Classifications	17
1.3 Service Requests Processing	19
Section 2: Application Phase	26
2.1 Application Submission.....	26
2.2 Generation Interconnection ASA Requirements	28
2.3 Merchant Transmission Facilities ASA Requirements	30
2.4 Long Term Firm Transmission Service ASA Requirements	32
2.5 ASA Deposits	33
2.6 Site Control	34
2.7 PJM ASA Review	35
2.8 Scoping Meeting.....	36
2.9 Base Case Model	36
2.10 Valid New Service Request	37
2.11 Withdrawal Prior to Phase I	37
Section 3: PJM Support for New Service Customer	38
3.1 Project Management and Client Management.....	38
3.2 PJM Membership.....	38
3.3 Membership in NERC Regional Councils	38

Section 4: Phases and Decision Points	40
4.1 New Service Requests Study Overview	40
4.2 Overview of System Impact Studies.....	41
4.3 Phase I System Impact Study	45
4.4 Decision Point I	49
4.5 Phase II System Impact Study	51
4.6 Decision Point II	55
4.7 Phase III System Impact Study	57
4.8 Decision Point III	58
4.9 New Service Request Connection Types	61
4.10 Other Related Studies Performed	66
Section 5: Final Agreement Negotiation Phase	70
5.1 Draft Agreement:	70
5.2 Negotiation:	71
5.3 Impasse	71
5.4 Project Developer or Eligible Customer Execution:	71
5.5 Transmission Owner Execution:	72
5.6 PJM Execution:	72
5.7 Proceeding under Interconnection Related Agreement:	72
Section 6: Study and Readiness Deposits	73
6.1 Study Deposits	73
6.2 Readiness Deposits.....	75
6.3 Deposit Timeline.....	78
6.4 Separate Treatment for Deposits and Security.....	79
Section 7: Site Control	81
7.1 Site Control Requirements.....	81
7.2 Site Control Requirements in the Cycle Process	85
Section 8: Summary of Agreements.....	93
8.1 Summary of Tariff Agreements	93

8.2 General Agreement Execution Deadlines.....	93
8.3 Summary of Non-Tariff Agreements.....	94
8.4 Agreements to Initiate Interconnection Related Request.....	95
8.5 Final Agreements	97
8.6 Additional Requirements for Final Agreements	101
8.7 Modifying Interconnection Related Agreements	103

Section 9: Generator Interconnection Requirements, Rights and Obligations 105

9.1 Requirements for Generating Facilities	105
9.2 Generator Power Factor Requirements.....	105
9.3 Application of Power Factor Requirements to Increases of Existing Generation	106
9.4 Electing Capacity Resource Status versus Energy Resource Status	107
9.5 Transfer of Capacity Interconnection Rights (CIRs)	108
9.6 State Agreement Approach (SAA) Capability	109
9.7 Changes to Existing or Proposed Generation/Transmission Facilities	111
9.8 Modification of New Service Requests at Cycle Decision Points	112
9.9 Multiple Requests Behind the Same Point of Interconnection (POI)	117
9.10 Station Power	117
9.11 Interconnection Procedures for FERC Jurisdictional Facilities and Non-FERC Jurisdictional Facilities	118
9.12 Behind the Meter Generation	119
9.13 Demand Response	122
9.14 Service below Generating Capability	122

Section 10: Transmission Interconnection Requests - Rights and Obligations 124

10.1 Rights.....	124
10.2 Obligations	124
10.3 Technical Design Requirements	125

Section 11: Upgrade Request	129
11.1 Overview	129
11.2 Upgrade Request Process	131
Section 12: Surplus Interconnection Service	140
12.1 Overview of Surplus Interconnection Service	140
12.2 Surplus Interconnection Request Process.....	141
12.3 Deactivation of Existing Generating Facility Providing Surplus Interconnection Service.....	145
Section 13: Affected System Studies	146
13.1 Introduction	146
13.2 Affected System Rules Where Affected System is an Electric System Other than PJM	147
13.3 Affected System Rules Where PJM’s Transmission System is the Affected System.....	149
Section 14: Converting a Two-Party Agreement to a GIA	154
14.1 Overview	154
14.2 Procedure to Convert a Two-Party Interconnection Agreement to a GIA	155
Attachment A: Interconnection Process Flow Diagram	158
Attachment B: Cost Allocation Procedures	159
B.1 Purpose	159
B.2 Scope	159
B.3 PJM Generation and Transmission Interconnection Cost Allocation Methodologies.....	159
Attachment C: Facilities Study Procedure	165
C.1 Introduction.....	165
C.2 Types of Facilities Studies	166
C.3 General Facilities Study Guidelines.....	166
C.4 Facilities Studies Report	167

Attachment D: HVDC Additional Study Requirements	173
D.1 Proposed Merchant D.C. Transmission Facilities and Their Dynamic Characteristics	173
D.2 Dynamic Performance Analysis	173
D.3 Sub-synchronous Torsional Analysis	174
D.4 AC System Harmonic Analysis	174
D.5 Studies required by Transmission Owner’s FERC-715 report	174
D.6 A.C. Ferro-Resonance Study	175
D.7 Power Line Carrier Filter Performance Verification	175
D.8 Field Investigation of Existing A.C. System Harmonic Content	175
D.9 Stability Analyses.....	175
Attachment E: Transmission Injection Rights and Transmission Withdrawal Rights	177
E.1 Summary of Transmission Injection Rights (TIRs) and Transmission Withdrawal Rights (TWRs).....	177
E.2 Procedure to Determine Transmission Injection Rights (TIRs) and Transmission Withdrawal Rights (TWRs)	178
E.3 Transmission Service Rate for TWR.....	179
Attachment F: Incremental Auction Revenue Rights	180
F.1 Incremental Auction Revenue Rights	180
F.2 Procedure to Determine Incremental Auction Revenue Rights (IARRs).....	181
Attachment G: Incremental Deliverability Rights	182
G.1 Incremental Deliverability Rights	182
G.2 Procedure to Determine Incremental Deliverability Rights (IDRs)	182
Attachment H: Incremental Capacity Transfer Rights and Qualified Transmission Upgrades.....	184
H.1 General ICTR Information	184
H.2 Procedure to Determine ICTRs	185

Attachment I: Transition Procedures	186
I.1 Introduction	186
I.2 Transition Cycle Overview	187
I.3 Transition Period Rules	189
I.4 AE1-AG1 Transition Cycle 1	193
I.5 AG2-AH1 Transition Cycle 2.....	194
I.6 Transition Cycle Phases and Decision Points	197
I.7 Site Control Requirements.....	199
I.8 Deposits	200
I.9 Additional Information Applicable to All Request Types	201
Appendix A – Transition Process Overview Diagram	201
Attachment J: Site Plan Requirements	203
J.1 Generation Interconnection Requests Site Plan	203
J.2 Transmission Interconnection Request Site Plan	206
Revision History	208

Table of Exhibits

Exhibit 1: M14 Series Manuals	16
Exhibit 2: New Service Request Processing	20
Exhibit 3: Service Request Diagram.....	20
Exhibit 4: Cycle Process Overview.....	22
Exhibit 5: Cycle Dependencies.....	23
Exhibit 6: Cycle Phase Summary	23
Exhibit 7: Required Study Deposit.....	33
Exhibit 8: Stability Analysis Activities in a Cycle.....	53
Exhibit 9: Generator Interconnection via New Interconnection Switchyard	61
Exhibit 10: Generator Interconnection into Existing TO Substation	62
Exhibit 11: Generator Interconnection as a Tap off of an Existing Line	62
Exhibit 12: Generator Interconnection to a Non-FERC Facility	63
Exhibit 13: Merchant Transmission Interconnection.....	64
Exhibit 14: Timeline for Winter CIR Study	69
Exhibit 15: Study Deposit Requirement.....	73
Exhibit 16: MW for Study Deposit Calculation.....	73
Exhibit 17: Study Deposit Refund.....	74
Exhibit 18: Readiness Deposit Requirements	76
Exhibit 19: Readiness Deposit at Risk	77
Exhibit 20: Deposit Timeline.....	79
Exhibit 21: Acceptable Forms of Deposits and Security.....	79

Exhibit 22: Generating Facility Acreage Requirements by Project Technology	84
Exhibit 23: Site Control Change Example: Allowable Changes Between Application and DP1	87
Exhibit 24: Site Control Change Example Continued: Allowable Changes Between DP1 and DP3.....	89
Exhibit 25: Site Control Term Requirements	91
Exhibit 26: Summary of Tariff Agreements.....	93
Exhibit 27: Summary of Non-Tariff Agreements	95
Exhibit 28: Generator Power Factor Requirements.....	105
Exhibit 29: Generator Power Factor Requirements for Increases to Existing Generation	106
Exhibit 30: Summary of Permitted Modifications	113
Exhibit 31: Multi-Fuel Request Example	116
Exhibit 32: Upgrade Request Process	132
Exhibit 33: Surplus Interconnection Service Example	141
Exhibit 34: Surplus Interconnection Request Process	142
Exhibit 35: Affected System Study Process	148
Exhibit 36: Affected System Facilities Study Process	150
Exhibit 37: Process for conversion from a two-party Interconnection Agreement to a GIA.....	155
Exhibit 38: Table AC Power System Characteristics at the Point of Interconnection	175
Exhibit 39: Transition Process Overview Diagram	188

Exhibit 40: Transition Cycle #1 Diagram	193
Exhibit 41: Transition Cycle #2 Diagram	195
Exhibit 42: Cycle Phase I, Phase II, Phase III Overview	197
Exhibit 43: Site Control Requirements	199
Exhibit 44: Site with Multiple Requests	203
Exhibit 45: Adding Non-contiguous Parcels to Site	204
Exhibit 46: Interconnecting into an Existing Substation.....	205
Exhibit 47: Tapping an Existing Transmission Line.....	206
Exhibit 48: Merchant Transmission Request Site Plan	207



Approval

Approval Date: 12/08/2025
Effective Date: 09/25/2025

Andrew Lambert, Manager

Interconnection Planning Projects

Current Revision

Revision 03 (09/25/2025):

- Changes to amend the existing interim deliverability process to identify and accredit energy-only operation of certain resources, in response to a problem statement issue charge for a quick fix to the existing process.
 - Section 4.10.1.1
 - Section 4.10.1.2
 - Section 4.10.1.3
 - Section 4.10.1.4

Introduction

Welcome to the New Service Requests Cycle Process Manual. In this Manual you will find:

- A table of contents
- An approval page that lists the required approvals and the revision history
- This Introduction
- Sections summarizing the application process, study process, and agreements tendered for any Project Developer or Eligible Customer that submits a New Service Request.
- Sections summarizing the application process, study process, and agreements tendered for any requests submitted by an Affected System Customer, Upgrade Customer or Surplus Project Developer.
- Attachments that include additional supporting documents and tables

About This Manual

This PJM Manual, ***New Service Requests Cycle Process*** is one of the PJM Manual 14 series family. This Manual guides Project Developers, Eligible Customers, Upgrade Customers, Surplus Project Developers and Affected System Customers through the planning and study phase of their proposed project up to the request for facility construction.

Applicability

This PJM Manual applies to:

- Any project for which the Project Developer, Eligible Customer or Upgrade Customer has submitted a New Service Request between April 1, 2018 and September 30, 2021 (AE1-AH1 New Service Requests), and for which, as of the Transition Date, PJM has not tendered for execution an ISA, WMPA or UCSA.

The following chart shows the timeframes of the various queue periods:

QUEUE WINDOW TIME PERIODS

Queue Window	Time Period
AD2 and before	Prior to March 31, 2018
AE1	April 1, 2018 through September 30, 2018
AE2	October 1, 2018 through March 31, 2019
AF1	April 1, 2019 through September 30, 2019
AF2	October 1, 2019 through March 31, 2020

AG1	April 1, 2020 through September 30, 2020
AG2	October 1, 2020 through March 31, 2021
AH1	April 1, 2021 through September 30, 2021

Note:

Transition procedures applicable only to the group of projects listed above are outlined in Attachment I of this manual.

- Valid **New Service Requests submitted on or after October 1, 2021**, that, as of the Transition Date, have not executed or been tendered any interconnected related agreement.

This PJM Manual provides the:

1. procedures and other terms governing PJM's administration of the Cycle process;
2. procedures and other terms regarding studies and other processing of New Service Requests;
3. the nature and timing of the agreements required in connection with the studies and construction of required facilities; and
4. terms and conditions relating to the rights available to Project Developers, Eligible Customers, Upgrade Customers and Affected System Customers.

Intended Audience

The intended audience for this PJM Manual includes the following:

- Any Project Developer, Eligible Customer, Upgrade Customer, or Affected System Customer, as applicable, who proposes to:
 - Interconnect new or upgrade existing generation on the PJM system
 - Build new or upgrade existing transmission facilities to obtain rights
 - Upgrade the rating of existing transmission facilities to acquire additional financial rights or customers seeking Incremental Auction Revenue Rights
 - Utilize Surplus Interconnection Service within the Transmission System in the PJM Region
 - Interconnect to an Affected System which requires Network Upgrades to the PJM Transmission System
- PJM Transmission Owners and other PJM Members and their staff
- PJM staff

Requirements for New Service Requests submitted prior to October 1, 2021 that, as of the Transition Date, have been tendered and/or executed any interconnected related final agreement are captured in Manuals 14A, 14E and 14G on the PJM website.

The Transition Date will be the later of:

1. the effective date of PJM's Docket No. ER22-2110 transition cycle filing seeking FERC acceptance of this Tariff, Part VII or
2. the date by which all AD2 and prior queue window Interconnection Service Agreements or wholesale market participation agreements have been executed or filed unexecuted.

Given that the condition (1) has occurred on January 3, 2023, date (2) above establishes the Transition Date.

Definitions

Capitalized terms not defined herein have the meaning set forth in the PJM Open Access Transmission, Energy and Operating Reserve Markets Tariff (Tariff), Parts VII and VIII.

Time Periods

Time periods specified in this manual are calendar days, unless otherwise noted as Business Days.

“Business Day” shall mean a day ending at 5pm Eastern prevailing time in which the Federal Reserve System is open for business and is not a scheduled PJM holiday.

If the last day of the time period does not occur on a Business Day, the required obligation/action must be met by the next Business Day.

References

The entire PJM Manual 14 series addresses issues that may be related to or of interest to a party that has submitted a New Service Request. The reader of this manual is urged to review the other manuals for additional material of interest. All PJM manuals can be found in the library section on PJM's website. In addition, the reader is urged to check PJM committee postings for possible draft revisions that may be awaiting posting under the Library/Manuals section of PJM.com.

Section 1: New Service Requests Process Overview and Determining Customer Type

Section 1 provides the following information:

- A description of PJM's interconnection process as outlined in the PJM Manual 14 series.
- A description of the purpose of the manuals included in the PJM Manual 14 series.
- The types of New Service Requests received by PJM and customer classifications.
- Guidance for the Project Developer, Eligible Customer, Upgrade Customer, Surplus Project Developer and Affected System Customer on their customer type, which PJM manuals to reference, and applicable Tariff attachments, studies, and agreements based on their customer type.

PJM Manuals offer a set of guidelines to ensure successful interconnection and operations within PJM.

Manual 14H Attachment A – Interconnection Process Flow Diagram - portrays the pertinent planning steps from the initial New Service Request up to the request for facility construction.

The PJM Manual 14H content is consistent with and elaborates on the terms and conditions found in the PJM source documents. The primary source documents for Manual 14H are the PJM Tariff and the PJM Operating Agreement.

Other applicable source documents may include the PJM Transmission Owners Agreement and the PJM Reliability Assurance Agreement. The source documents remain the final authoritative documents and these documents control with regard to any inconsistencies between them and the PJM Manuals.

1.1 PJM New Service Request Process Overview

The PJM Regional Transmission Organization (RTO) has the responsibility for planning the expansion and enhancement of the PJM Transmission System on a regional basis. As the RTO, PJM administers the interconnection of generators and Merchant Transmission Facilities, requests for Transmission Service and upgrades to existing Transmission Owner facilities in the PJM Transmission System through the New Service Requests process. In this role, PJM coordinates the planning process, performs reliability studies, and oversees the construction of the required Interconnection Facilities, Merchant Transmission Facilities, and any associated Network Upgrades.

PJM Manual 14H describes the New Service Requests process which outlines how entities request the interconnection of a Generating Facility (including increases to the capacity of an existing generating unit or decommissioning of a generating unit), the interconnection of a

Merchant Transmission Facility (including upgrades to an existing Merchant Transmission Facility), requests for Transmission Service, or upgrades to existing Transmission Owner facilities within the PJM RTO.

This process ensures the successful, timely completion of PJM’s planning, facility construction, and operational and market infrastructure requirements. For the purposes of this Manual, the term “Project Developer” shall mean a Generation Project Developer and/or Transmission Project Developer.

Manual 14H is one of the manuals in a series of PJM Planning Manuals which cover all aspects of Transmission Planning including customer interconnections and transmission expansion. The Manual 14 series manuals are outlined below:

Manual	Title	Description
14A	New Service Request Process	Guides New Service Customers through the general application, study and agreement process. See Note below.
14B	PJM Region Transmission Planning Process	Describes the process of planning baseline expansion facilities and basecase development.
14C	Interconnection Facilities and Network Upgrade Construction	Covers the lifecycle of a project from the agreement execution to commercial operation and describes the process of tracking RTEP projects.
14D	Generator Operational Requirements	Identifies the markets and operation requirements for generators to connect to the PJM system.
14E	Upgrade and Transmission Interconnection Requirements	Identifies specific requirements, study and agreement overview, and rights for Upgrade Requests and Merchant Transmission Interconnection Projects proposed on the PJM system. See Note below.
14F	Competitive Planning Process	Outlines the process to conduct the competitive proposal windows consistent with the FERC Order No. 1000.

14G	Generation Interconnection Requests	Identifies Interconnection Requirements, upgrade requirements, study/agreement overview, and rights for a generation Interconnection Customer. See Note below.
14H	New Service Requests Cycle Process	Describes the application and study process, agreements tendered and rights for any Project Developer or Eligible Customer Affected System Customer, Upgrade Customer or Surplus Project Developer that submits a request to PJM.

Exhibit 1: M14 Series Manuals

Note:

Manuals 14 A, E and G only apply to:

(a) any New Service Request received prior to April 1, 2018; and

(b) any New Service Request which, as of the Transition Date (defined in Tariff, Part VII), the Interconnection Customer has received for execution an Interconnection Service Agreement or wholesale market participation agreement or has directed the PJM to file an Interconnection Service Agreement or wholesale market participation agreement unexecuted.

1.2 New Service Request Customer Classifications

1.2.1 Generation Project Developer:

The PJM Tariff classifies a party wishing to perform the following on the PJM Transmission System as a **Generation Project Developer**:

- Interconnect a new generation facility to the Transmission System in the PJM region
- Increase the capacity of an existing generation facility interconnected with the Transmission System in the PJM region
- Modify the fuel type of an existing facility or generation interconnection request or
- Interconnect a generating unit to distribution facilities located in the PJM Region that are used to make wholesale sales using the output of the generating unit.

1.2.2 Transmission Project Developer

The PJM Tariff classifies a party wishing to perform the following on the PJM Transmission System as a **Transmission Project Developer**:

- Interconnect or add new Merchant Transmission Facilities to the Transmission System
- Increase the capacity of existing Merchant Transmission Facilities interconnected with the Transmission System

The following are examples of Merchant Transmission Facilities that can be proposed by Transmission Project Developers:

1.2.2.1 Merchant D.C. Transmission Facilities

Any Merchant D.C. (direct current) Transmission Facilities that interconnect to the Transmission System.

1.2.2.2 Controllable A.C. Merchant Transmission Facilities

Any Controllable A.C. (alternating current) Merchant Transmission Facilities that employ technology that PJM reviews and verifies will permit control of the amount and/or direction of power flow on such facilities to such extent to effectively enable the controllable facilities to be operated as if they were direct current Transmission Facilities.

1.2.2.3 Merchant A.C. Transmission Facilities

Any Merchant A.C. (alternating current) Transmission Facilities, other than those that are Controllable A.C. Merchant Transmission Facilities.

1.2.3 Eligible Customer

The PJM Tariff classifies the following as an **Eligible Customer**:

- Any electric utility (including any Transmission Owner and any power marketer), Federal power marketing agency, or any person generating electric energy for sale or for resale
- Any retail customer taking unbundled transmission service pursuant to a state requirement that PJM or a Transmission Owner offer the transmission service, or pursuant to a voluntary offer of such service by a Transmission Owner.

1.2.4 Upgrade Customer

The PJM Tariff classifies a party wishing to perform the following on the PJM Transmission System as an **Upgrade Customer**:

- Request Incremental Auction Revenue Rights pursuant to Section 7.8 of the Operating Agreement and the parallel provisions of the Tariff.
- Propose to increase the capability of existing Transmission Owner Facilities, or
- Advance the construction of any transmission enhancement or expansion other than Merchant Transmission Facilities, that is part of the Transmission System or included in the

Regional Transmission Expansion Plan prepared pursuant to Schedule 6 of the Operating Agreement.

1.2.5 Surplus Project Developer

The PJM Tariff classifies a party described below as a **Surplus Project Developer**:

- A Project Developer whose Generating Facility is already interconnected to or has executed (or requested to file unexecuted) an Interconnection Service Agreement or Generation Interconnection Agreement to interconnect to the PJM Transmission System or one of its affiliates, or an unaffiliated entity that submits a Surplus Interconnection Request to utilize Surplus Interconnection Service within the Transmission System in the PJM Region.

1.2.6 Affected System Customer

The PJM Tariff classifies a party described below as an **Affected System Customer**:

- A developer that is responsible for a new, expanded or upgraded generation or transmission facility outside of PJM's transmission system that requires Network Upgrades to PJM's Transmission System.

1.2.7 Project Developers Seeking to Convert a Two-Party Interconnection Agreement to a GIA:

Project Developers with existing generators already interconnected to PJM that are currently operating under a two-party Interconnection Agreement, a power purchase agreement, or both, and seek to convert to a PJM three-party GIA due to a transfer of ownership or the power purchase agreement expiring or being terminated are subject to a review process and will enter into a Cost Responsibility Agreement as set forth in Tariff, Part IX, Subpart F.

1.3 Service Requests Processing

New Service Requests are processed in two broad categories:

- Requests under the Cycle process
- Requests under a parallel process

Sections 2 thru 5 of this manual provides an overview of the New Service Requests that will follow the Cycle process timeline. Sections 11 thru 14 outline requests that follow a parallel process.

Generation and Transmission Interconnection Requests as well as eligible Long Term Firm projects will follow the Cycle Process. However, Upgrade Requests, Surplus Service Requests, Affected System Facilities Study requests and requests to convert a non-PJM two-party agreement to a PJM GIA will follow a parallel process.

The diagram below depicts how service requests are processed.

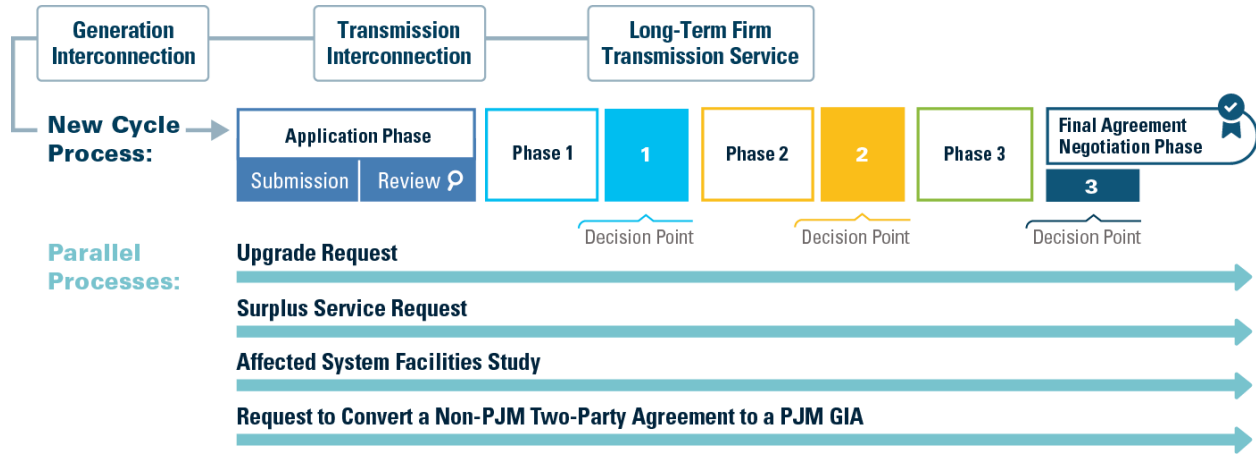

Exhibit 2: New Service Request Processing

1.3.1 Service Request Diagram

According to the Tariff, there are different agreements required to request service depending on the type of service being requested. The following chart depicts the various service requests, the associated customer types, and the study process flow through final agreements.

Customer Type	Request Type	Entry /Initial Agreement	Studies	Rights	Final Agreements (See Note 1)
Generation Project Developer	Generation Interconnection Request	Application and Studies Agreement	Phase I , II & III System Impact Studies Facilities Study	CIR, energy resource rights	GIA WMPA CSA NUCRA
Transmission Project Developer	Transmission Interconnection Request	Application and Studies Agreement	Phase I , II, & III System Impact Studies Facilities Study	<u>Within PJM's footprint:</u> ICTR, IARR, IDR <u>Between two</u>	GIA CSA NUCRA

				<u>Control Areas:</u> TWR, TIR or ICTR, IARR, IDR	
Eligible Customer	Long Term Firm Transmission Service Request	Completed Application + Application and Studies Agreement	Phase I , II, & III System Impact Studies Facilities Study	None	TSA (NITSA) CSA NUCRA
Upgrade Customer (Transmission Facilities)	Upgrade Request	Upgrade Application Study Agreement	System Impact Study Facilities Study	ICTR and IARR	UCSA NUCRA
Upgrade Customer (IARR)	Upgrade Request	Upgrade Application and Studies Agreement	Market Requirements System Impact Study Facilities Study	IARR	UCSA NUCRA
Surplus Project Developer	Surplus Interconnection Request	Surplus Interconnection Service Study Agreement	System Impact Study	None	GIA
Affected System Customer	Affected System Facilities Study	Affected System Customer Facilities Study Application and Agreement	Facilities Study	None	CSA NUCRA
Project Developers seeking to convert an existing two-party	Request to convert an existing two-party agreement to a GIA	Cost Responsibility Agreement	None	CIR	GIA CSA

agreement to a PJM GIA					
------------------------	--	--	--	--	--

Exhibit 3: Service Request Diagram

Note:

Additional information on final agreements referenced in this table is provided in Section 8 of this manual.

1.3.2 Cycle Process Overview

A Cycle is the period of time between the start of an Application phase and conclusion of the corresponding Final Agreement Negotiation Phase. Each Cycle consists of the: Application Phase, Phase I, Decision Point I, Phase II, Decision Point II, Phase III, Decision Point III, and the Final Agreement Negotiation Phase.

Exhibit (Cycle Process Overview) below provides an overview of the different phases in a Cycle and the activities performed in each phase.

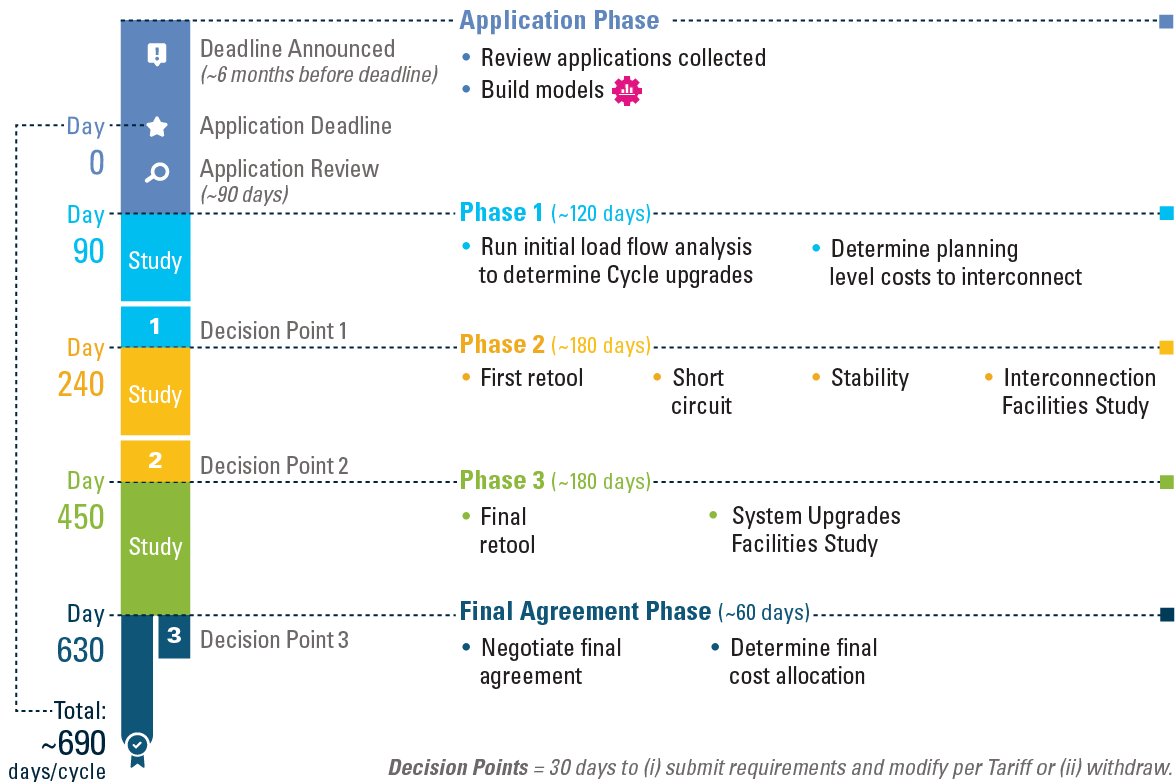

Exhibit 4: Cycle Process Overview

Certain activities in a subsequent Cycle cannot begin until milestones in a prior Cycle have been met.

Exhibit (Cycle Dependencies) below highlights the dependencies between a prior Cycle and the subsequent Cycle.

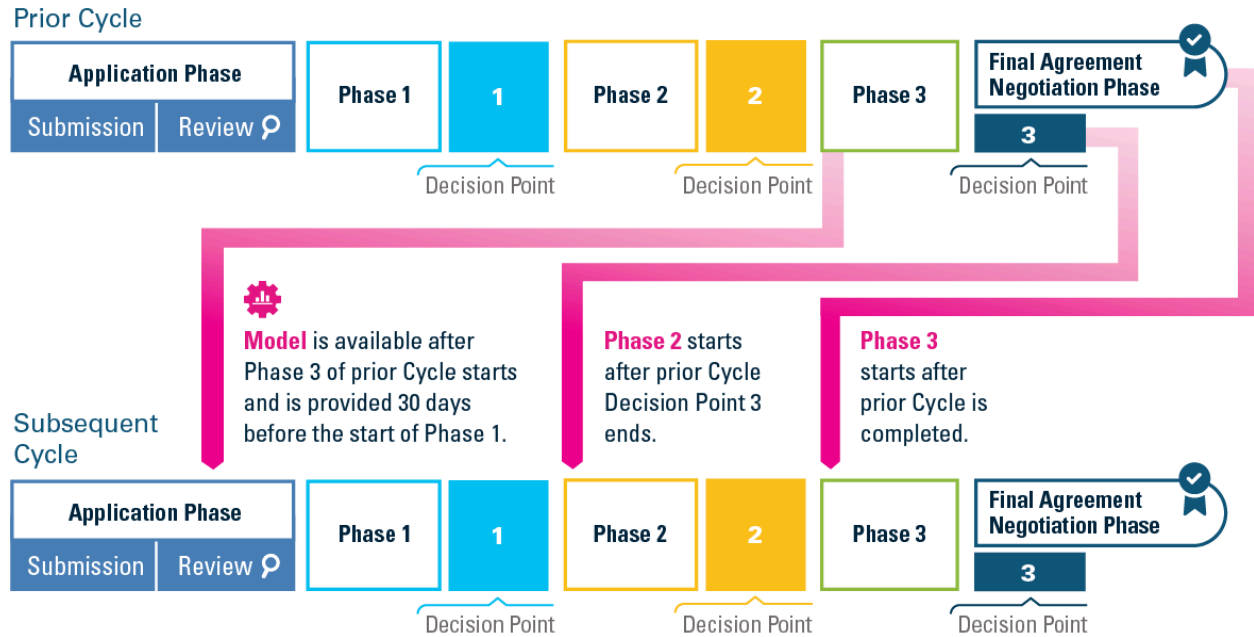

Exhibit 5: Cycle Dependencies

A summary of the activities performed in each phase of a Cycle is provided in the table below. Details are provided in subsequent sections of this manual.

Phase	Description
Application Phase	The Cycle period that includes both the submission and review of New Service Requests. The Project Developer or Eligible Customer submits an Application and PJM reviews and validates the submission and assigns a Project Identifier.
Phase I , Phase II and Phase III	Phase I starts on the first Business Day immediately after the close of the Application Review Phase of a Cycle, but no earlier than 30 calendar days following the distribution of the Phase I Base Case Data. During Phase I, PJM conducts the Phase I System Impact Study.

	<p>Phase II starts on the first Business Day immediately after the close of Decision Point I Phase unless the Decision Point III of the immediately preceding Cycle is still open. Phase II of a Cycle cannot begin before the conclusion of Decision Point III of the immediately preceding Cycle. During Phase II, PJM conducts the Phase II System Impact Study.</p> <p>Phase III starts on the first Business Day immediately after the close of Decision Point II, unless the Final Agreement Negotiation Phase of the immediately preceding Cycle is still open. Phase III of a Cycle cannot commence before the conclusion of the Final Agreement Negotiation Phase of the immediately preceding Cycle. During Phase III, PJM conducts the Phase III System Impact Study.</p>
<p>Decision Points I, II, and III</p>	<p>Each Decision Point is a period of 30 calendar days commencing on the first Business Day immediately following the prior Phase of the Cycle. Decision Point III runs concurrent with the Final Agreement Negotiation Phase. If the 30th calendar day does not fall on a Business Day, the time period shall conclude on the next Business Day. At each Decision Point, the Project Developer or Eligible Customer:</p> <ol style="list-style-type: none"> 1. Notifies PJM of decision to proceed to the next phase or withdraw 2. Provides required data, evidence (such as permits, site control, etc.) and deposits as specified in the PJM Tariff 3. Submits any modifications as permitted by the Tariff, and 4. May accelerate to final agreement, if applicable. <p>PJM reviews information provided and validates customer submission and moves the customer to next phase.</p>
<p>Final Agreement Negotiation Phase</p>	<p>The phase described in Tariff, Part VII, Subpart D, section 314 or Tariff, Part VIII, Subpart D, section 411 to tender, negotiate, and execute any service agreement in Tariff, Part IX.</p>

Exhibit 6: Cycle Phase Summary

1.3.3 Parallel Processes

The following requests will be processed separately outside of the Cycle process:

1. Upgrade Requests
2. Surplus Interconnection Requests
3. Affected System Study process
4. Requests to convert existing two-party Interconnection Agreement to a GIA.

Details on PJM's processing of each request type are captured in sections 11 thru 14 of this manual.

1.3.4 Tariff Rights

The final agreements as applicable specify the rights to which the Project Developer or Eligible Customer is entitled as described in Tariff, Part VII, Subpart E, sections 328, 329, 330 and 332 and Tariff, Part VIII, Subpart E, sections 426, 427, 428, and 430.

Section 2: Application Phase

Section 2 outlines the requirements of the Application Phase of the Cycle Process. Complete procedures are provided in Tariff, Part VII, Subpart C and Tariff, Part VIII, Subparts A and B.

2.1 Application Submission

2.1.1 Initiating a New Service Request

A New Service Request is required for requests to or for:

1. interconnect a Generating Facility to the Transmission System in PJM Region,
2. increase the capability of a Generating Facility in PJM Region,
3. interconnect Merchant Transmission Facilities with the Transmission System,
4. increase the capability of existing Merchant Transmission Facilities interconnected to the Transmission System,
5. interconnect a Generating Facility to distribution facilities located in PJM Region that are used for transmission of power in interstate commerce, and to make wholesale sales using the output of the Generating Facility, or
6. Long Term Firm transmission service outside of the 18 month Available Transfer Capability (ATC) horizon

To initiate a New Service Request:

- Project Developer electronically submits to PJM, an Application and Studies Agreement (ASA) provided in Tariff, Part IX, Subpart A through the PJM data submission tool on PJM website. The PJM data submission tool guides the Project Developer through the application process and collects all of the required information for application submission.
- In contrast, an Eligible Customer electronically first submits an application through PJM Open Access Same-Time Information System (OASIS) and subsequently executes the ASA following the procedures outlined in Tariff, Parts II and III as applicable. PJM drafts and issues the ASA to the customer for execution after the OASIS Completed Application is received, if it is determined that a Phase I System Impact Study is required to evaluate the requested service.
- To be considered in a Cycle, Project Developers and Eligible Customers must satisfy all the requirements outlined in Tariff, Part VII, Subpart C, section 306, Application Rules or Tariff, Part VIII, Subpart A, section 401 Application for Cycle Process, and Subpart B, section 403 Application Rules.

2.1.2 Application Requirements

PJM will post a firm Application Deadline for a Cycle at the beginning of Phase II of the immediately prior Cycle, no less than 180 days in advance of the Application Deadline. The Application Deadline will be published on PJM website. A notification will also be distributed to Project Developers and Eligible Customers. Only completed New Service Requests received by the Application Deadline will be considered for the corresponding Cycle.

For a Project Developer application to be considered complete, and considered in a Cycle, in addition to the requirements in Tariff Part VII, Subparts C and Tariff Part VIII, Subparts A and B, PJM must receive the following items prior to Application Deadline of the Cycle:

1. Completed and executed ASA
2. Technical information as requested by the PJM data submission tool
3. Wire transfer (with reference number noted) for entirety of Study Deposit
4. Wire Transfer (with reference number noted) OR Letter of Credit for entirety of Readiness Deposit No. 1
5. Evidence of Site Control

Note:

Modeling Data required for Stability analysis must be provided with the submitted application in PJM data submission tool. Project Developers shall follow PJM Dynamic Model Development Guidelines on the PJM website to submit stability data specific to their project. Project Developers should pay special attention to PJM Dynamic Model Development Guidelines to ensure all deliverables are met. If stability data submission is not approved at the end of the deficiency review period, the application will be withdrawn.

For an Eligible Customer's application to be considered in a Cycle, Eligible Customer must submit a Completed Application to PJM prior to the Cycle's Application Deadline.

If PJM determines that a Phase I System Impact Study is required to evaluate the service request, following the receipt of the Completed Application, PJM will follow the procedures outlined in Tariff Part II Section 19.1 or Part III Section 29.2 as applicable and tender an ASA to the Eligible Customer for execution.

For a service request to remain a Completed Application, the Eligible Customer shall:

1. execute the ASA and return it to PJM within fifteen (15) days; and
2. provide a wire transfer (with reference number noted) for entirety of Study Deposit; and
3. provide a wire transfer (with reference number noted) OR Letter of Credit for entirety of Readiness Deposit No. 1.

Completed New Service Requests will be assigned a Project Identifier. PJM will review and validate completed New Service Requests during the application review prior to the start of Phase I.

2.2 Generation Interconnection ASA Requirements

2.2.1 General Generation Interconnection Application Requirements:

- a) Provide all applicant information required in the ASA, including parent company information and banking and wire transfer information.
- b) Specify the location of the proposed Point of Interconnection to the Transmission System, including the substation name or the name of the line to be tapped (including the voltage), the estimated distance from the substation endpoints of a line tap, address, and GPS coordinates. (See item e below for additional details)
- c) Provide information about the Generating Facility project, including whether it is:
 - (1) a proposed new Generating Facility,
 - (2) an increase in capability of an existing Generating Facility, or
 - (3) the replacement of an existing Generating Facility.
- d) Indicate the type of Interconnection Service requested, whether (1) Energy Resource only or (2) Capacity Resource (includes Energy Resource) with Capacity Interconnection Rights. (See item 'i' below)
- e) Specify the project location and provide a detailed Site plan showing:
 1. Generator Facility location including main GSU
 2. Point of Interconnection to the transmission or distribution system.
 3. Generator Facility Site boundaries.
 4. If multiple projects using same Site, please delineate the boundaries for each individual project Site.

Refer to Section 7 of this manual for additional Site plan requirements.
- f) Submit required evidence of Generating Facility Site Control (including the location of the main step-up transformer), including a certification by an officer or authorized representative of Applicant; and, at PJM's request, copies of landowner attestations or county recordings.
- g) Provide information about Qualifying Facility status under the Public Utility Regulatory Policies Act, as applicable.

- h) Submit required information and documentation if the Generating Facility will share applicant's Interconnection Facilities with another Generating Facility.
- i) For a new Generating Facility, specify requested Maximum Facility Output and Capacity Interconnection Rights.

Note:

If applicant is claiming CIRs from a deactivated unit, applicant must submit any claim from the deactivating generating units with their application, and it must be received by the Application Deadline. CIR claims must be submitted using the CIR Transfer template available on the PJM website.

- j) For a requested increase in generation capability of an existing Generating Facility, specify the existing Maximum Facility Output and Capacity Interconnection Rights, and requested increases. If project is an uprate, specify prior queue position number(s) or project identifier number(s).
- k) Provide a detailed description of the equipment configuration and electrical design specifications for the Generating Facility.
- l) Specify the fuel type for the Generating Facility; or, in the case of a multi-fuel Generating Facility, the fuel types.
- m) For a multi-fuel Generating Facility, provide a detailed description of the physical and electrical configuration. Applicant will need to specify MW capability for each fuel type. Data entry tool will prompt for any additional required information.
- n) If the Generating Facility will include a storage component, applicant must provide detailed information about:
 - 1. whether and how the storage device(s) will charge using energy from the Transmission System,
 - 2. the primary frequency response operating range for the storage device(s),
 - 3. the MWh stockpile, and
 - 4. the hour class, as applicable.

If project includes battery storage, that data entry submission tool will prompt for any additional required information.

Note:

The stockpile measures the storage capacity of the battery Site which is the product of the battery power rating (MW) and the duration (h).

o) Specify the proposed date that the project or uprate associated with the application will be in service. (The actual in-service date will depend on study timelines and Transmission Owner construction timelines).

2.2.2 Behind the Meter Generation Interconnection Application Requirements:

If Behind the Meter, the following additional information will be required as set forth in Tariff, Part VII, Subpart C, section 306(A)(2) and Tariff, Part VIII, Subpart B, section 403(A)(2) and summarized below: Additional information is available in Part VII, Subpart E, Section 317 and Part VIII, Subpart E, Section 415.

a) Specify gross output, behind the meter load, requested Maximum Facility Output, and requested Capacity Interconnection Rights.

b) For a requested increase in generation capability of an existing Behind the Meter Generating Facility, specify existing and requested increase in gross output, behind the meter load, Maximum Facility Output, and Capacity Interconnection Rights.

2.3 Merchant Transmission Facilities ASA Requirements

The PJM data submission tool will guide the user to enter all the required information for an application to be considered complete. The requirements for a Merchant Transmission ASA to be considered in a Cycle are provided in Tariff, Part VII, Subpart C, section 306A(4) and Tariff, Part VIII, Subpart B, section 403A(4) and summarized below.

2.3.1 General Requirements

For PJM to consider an ASA for a Transmission Interconnection Request complete, the ASA must at a minimum:

a) Provide all applicant information required in the application, including parent company information and banking and wire transfer information.

b) Specify the location of the proposed facilities, and the name and description of the substation where applicant proposes to interconnect or add its facilities.

c) Specify the proposed voltage (kV) and nominal capability (MVA) of new facilities or Increase in capability (MVA) of existing facilities.

d) Provide a detailed description of the equipment configuration and electrical design specifications for the project. Data entry tool will prompt for required information.

e) Specify the proposed date that the project or increase in capability will be in service. (The actual in-service date will depend on study timelines and TO construction timelines).

f) Specify whether the proposed facilities will be either:

- (1) Merchant A.C. Facilities,
- (2) Merchant D.C. Transmission Facilities, or
- (3) Controllable A.C. Merchant Transmission Facilities.

g) If Merchant D.C. Transmission Facilities or Controllable A.C. Merchant Transmission Facilities, specify whether applicant elects to receive:

1. Firm or Non-Firm Transmission Injection Rights (TIR) and/or Firm or Non-Firm Transmission Withdrawal Rights (TWR) or
2. Incremental Delivery Rights (IDR), Incremental Auction Revenue Rights (IARR), and/or Incremental Capacity Transfer Rights (ICTR)

i. If Applicant elects to receive TIRs or TWRs, specify:

1. total project MWs to be evaluated as Firm (capacity) injection for TIR;
2. total project MWs to be evaluated as Non-firm (energy) injection for TIR;
3. total project MWs to be evaluated as Firm (capacity) withdrawal for TWR; and
4. total project MWs to be evaluated as Non-firm (energy) withdrawal for TWR.

ii. If applicant elects to receive Incremental Delivery Rights, specify the location on the Transmission System where it proposes to receive Incremental Delivery Rights associated with its proposed facilities.

h) If the proposed facilities will be Controllable A.C. Merchant Transmission Facilities, and the applicant contractually binds itself in its interconnection-related service agreement to always operate its Controllable A.C. Merchant Transmission Facilities in a manner effectively the same as operation of D.C. transmission facilities, then the interconnection related service agreement will provide applicant with the same types of transmission rights that are available under the Tariff for Merchant D.C. Transmission Facilities.

In the application, applicant shall represent that, if it executes an interconnection-related service agreement for its project described in the application, it will agree in that service agreement to operate its facilities continuously in a controllable mode.

i) Specify the Site where applicant intends to install its major equipment (e.g. PAR, VFT, Transformer, SVC, substation or switchyard), and provide a detailed Site plan. Reference item (b) above. The following guidelines apply:

1. For new substation/switchyard or additional substation equipment (PAR, VFT, SVC, Transformer), applicant shall provide GPS coordinates of the intended equipment location.
2. For AC or HVDC transmission lines, PJM does not require a Site plan for the actual line route, in the Application Phase.

3. For HVDC line, applicant must provide a Site plan for converter stations.

j) Submit required evidence of Site Control for the major equipment (e.g. PAR, VFT, Transformer, SVC, substation or switchyard), including a certification by an officer or authorized representative of applicant; and, at PJM's request, copies of landowner attestations or county recordings.

k) Provide evidence acceptable to PJM that applicant has a valid interconnection request with the adjacent Control Area(s) in which it is interconnecting, as applicable. Applicant shall maintain its queue position(s) or equivalent with such adjacent Control Area(s) throughout the entire PJM Transmission Interconnection Request process for the relevant PJM Transmission Interconnection Request. For example, if the applicant requests to construct a transmission tie line between PJM and NYISO, applicant must demonstrate they have a valid request in NYISO queue and provide the project identifier.

If applicant fails to maintain its queue position(s) or equivalent with that adjacent Control Area(s) throughout the entire PJM Transmission Interconnection Request process for the relevant Cycle, the request will be terminated and withdrawn.

2.4 Long Term Firm Transmission Service ASA Requirements

Eligible Customers use PJM OASIS to request transmission service. The PJM Oasis tool will guide the user to enter all the required data for an application to be considered complete.

The requirements for a Long Term Firm Transmission Service Application to be considered in a Cycle are provided in Tariff, Part VII, Subpart C, section 306(3) and Tariff, Part VIII, Subpart B, section 403(A)(3) and summarized below. In addition, Tariff, Part II Section 17, Tariff Part III Section 29 and PJM Manual M2 provide additional information on the application requirements through OASIS.

OASIS requests received for Long Term Firm Transmission Service that fall outside of the Available Transfer Capability ("ATC") horizon of 18 months must be evaluated along with the other requests for service in the Cycle. PJM tenders an ASA to the Eligible Customer for execution after the completed application is received.

For PJM to consider an ASA for Long Term Firm Transmission Service complete, applicant must include at a minimum each of the following:

- a. Applicant information required in the ASA, including Parent company information and the banking and wire transfer information.
- b. the locations of the Point(s) of Receipt and Point(s) of Delivery.
- c. the requested Service Commencement Date and term of service.

d. the transmission capacity requested for each Point of Receipt and each Point of Delivery on the Transmission System.

2.5 ASA Deposits

Each New Service Request must submit a Study Deposit and Readiness Deposit No. 1, the amount of which will be determined based on the MWs requested in the application.

2.5.1 Study Deposit:

The Study Deposit applies to all required studies for an application to be processed via the Cycle Process. This is a one-time deposit that covers studies for Phase I, Phase II and Phase III of the interconnection process. Ten percent of the Study Deposit is non-refundable. Ninety percent of the Study Deposit is refundable.

Please note that the Study Deposit is non-binding and actual costs may exceed the Study Deposit. The applicant is responsible for, and must pay, all actual study costs. If study costs exceed the Study Deposit, PJM will send the applicant notification and the applicant must pay the additional costs within 20 Business Days.

The Study Deposit shall be calculated as follows, based on the MW energy (e.g. Maximum Facility Output (MFO)) or MW capacity (e.g. Capacity Interconnection Rights, Transmission Injection Rights or Transmission Withdrawal Rights), whichever is greater.

Project Size	Study Deposit
0-20 MW	\$75,000
>20-50 MW	\$200,000
>50-100 MW	\$250,000
>100-250 MW	\$300,000
>250-750 MW	\$350,000
>750 MW	\$400,000

Exhibit 7: Required Study Deposit

Additional Study Deposit requirements are captured in section 6 of this manual.

Note:

For instances where MFO is not being increased but there is an addition of generation, the deposit will be based upon the capability of the generation being added and not the requested MFO.

On a multi-fuel project, the deposits will be based on the capability of the generation being added.

2.5.2 Readiness Deposit #1

Pursuant to Tariff, Part VII, Subpart C, section 306 (A)(5)(b) and Part VIII, Subpart B, section 403 (A)(5)(b), Readiness Deposit No. 1 is an amount equal to \$4,000 per MW required with the submitted ASA. The MW values used in the calculation is the greater of (1) and (2) specified in the Application:

1. MW energy (e.g., Maximum Facility Output)
2. MW capacity (e.g., Capacity Interconnection Rights)

For New Service Requests in Transition Cycle No. 1, Readiness Deposit #1 is not at risk of being forfeited prior to the start of Phase II. However, for New Service Requests in Transition Cycle No. 2 and beyond, Readiness Deposit #1 is not at risk of being forfeited prior to the start of Phase I. Additional Readiness Deposit requirements and at-risk criteria are captured in section 6 of this manual.

2.6 Site Control

Pursuant to Tariff, Part VII, Subpart C, section 306 and Part VIII, Subpart A, section 402, in the Application Phase for a Generation Interconnection Request, Site Control is evidence provided by the Project Developer to PJM in relation to Project Developer's New Service Request demonstrating Project Developer's interest in, control over, and right to use the Site for the purpose of constructing a Generating Facility.

In the case of an application for Merchant Transmission, Site Control is evidenced by the Project Developer demonstrating Project Developer's interest in, control over, and right to use the Site for HVDC converter stations, phase angle regulators and or variable frequency transformers, as applicable.

Proof of Site Control can be in the form of one of the following:

- (1) deed;
- (2) lease;
- (3) option to lease or purchase; or

(4) as deemed acceptable by PJM, any other contractual or legal right to possess, occupy and control the Site

Note:

Memorandums are not acceptable as evidence of Site Control. Additionally, documentation solely evidencing an intent to purchase or control a Site is not acceptable evidence of Site Control.

Site Control must be in the name of the Project Developer identified on the corresponding New Service Request. Otherwise, the Project Developer must demonstrate to PJM's satisfaction the relationship between the entity owning or controlling the Site (landowner or owner) with Site Control and the Project Developer identified on the New Service Request.

For details on what is required with the Site Control documentation and the required term of the Site Control that needs to be evidenced at certain Decision Points in the Cycle process, see Section 7 of this Manual and Tariff, Part VIII, Subpart A, section 402, Tariff, Part VIII, Subpart B, section 403, and relevant sections in Tariff, Part VIII, Subpart C, sections 404-411.

2.7 PJM ASA Review

PJM will only review an ASA during the application review phase following the Application Deadline.

The duration of the application review phase will be the greater of 90 days or the amount of time it takes to complete all application review activities for the relevant Cycle.

1. After the close of the Application Deadline, PJM will begin the application review phase, where PJM reviews applications received from Project Developers for completeness and then establishes the validity of such submitted applications, beginning with a deficiency review, as follows:
 - a. PJM will use Reasonable Efforts to inform applicant of application deficiencies within 15 Business Days after the Application Deadline.
 - b. Applicant then has 10 Business Days to respond to PJM's deficiency determination.
 - c. PJM then will use Reasonable Efforts to review applicant's response within 15 Business Days, and then will either validate or reject the application.
2. For Eligible Customers, PJM reviews the application for completeness and then establishes the validity of the application.

Note:

Upon notification that a project is deficient, the applicant's 10 Business Day deficiency clock starts. This is a rolling clock that does not stop once a deficiency response is returned to PJM.

PJM will exercise Reasonable Efforts to review the ASA within this window. However there is no guarantee a response will be provided prior to the window expiring. If deficiencies remain following expiration of the 10 Business Day rolling deficiency window, the project is at-risk of being terminated from the Cycle for failure to cure all noted deficiencies.

2.8 Scoping Meeting

During the application review period, PJM, at its discretion, may hold one or more scoping meetings for projects in each Transmission Owner zone. The meetings are optional and may be waived by applicants or Transmission Owner, if they provide written notification to PJM. At PJM's discretion, scoping meetings may include discussion of potential Affected System needs.

A schedule with proposed dates and times for scoping meetings will be provided to Project Developers and Eligible Customers. Project Developers and Eligible Customers can sign up for meeting slots for their respective projects.

The purpose of the scoping meeting is to confirm the Point of Interconnection of the project onto the transmission system for modeling purposes. This is to ensure the project is properly modeled prior to the start of Phase I System Impact Study. PJM analysis engineers may also clarify any concerns with the Project Developer's or Eligible Customer's submitted project application data. Questions or concerns beyond this scope are to be addressed with the project's assigned PJM project manager.

2.9 Base Case Model

During the Application Review Phase, and at least 30 days prior to initiating Phase I of the Cycle, PJM will post the Phase I base case data for review. Specifically, the PSSE summer peak base case model for the Cycle will be available to comply with Tariff, Part VII, Subpart E, section 318 or Tariff, Part VIII, Subpart E, section 416.

Project Developers and Eligible Customers must submit a Critical Energy Infrastructure Information (CEII) request on PJM website, in order to be granted access to the model. Access to the model will be granted upon approval of the CEII request.

2.10 Valid New Service Request

When an application results in a valid New Service Request, PJM will confirm the assigned Project Identifier to the New Service Request. For Project Developers and Eligible Customers, the Project Identifier will indicate the applicable Cycle, and will denote a number that represents the project within the Cycle. The Project Identifier is strictly for identification purposes, and does not indicate priority within a Cycle.

The Project Identifier will have the format: **CXX-XXXX**. The first three characters identify the Cycle number and the last four characters identify the project within the Cycle. For example a project with Project Identifier: **C01-0001** is project 1 in Cycle 1.

PJM and the Project Developer or Eligible Customer are to reference the Project Identifier in all correspondence, submissions, wire transfers, documents, and other materials relating to the New Service Request.

2.11 Withdrawal Prior to Phase I

Prior to the start of Phase I, a Project Developer or Eligible Customer may request to withdraw its New Service Request or may be withdrawn from the Cycle by PJM for failure to meet the Application Phase requirements, without forfeiting Readiness Deposit No. 1. Readiness Deposit No. 1 is not at risk prior to the start of Phase I. Refer to Section 6 of this manual for additional information on Readiness Deposits.

Section 3: PJM Support for New Service Customer

Section 3 describes the support a New Service Request customer will receive upon submitting a valid New Service Request. It also defines membership privileges.

3.1 Project Management and Client Management

PJM assigns a project manager to a New Service Request after a New Service Request is submitted. The project manager will be responsible for working with each Project Developer or Eligible Customer and its respective staff to complete the necessary steps related to interconnection planning. Additional project managers will be assigned for subsequent facility construction and operational phases of the project.

After contacting PJM for the first time through PJM's hotline or through PJM's web site, the Project Developer or Eligible Customer will be assigned a client manager. Client managers coordinate PJM activities that facilitate each Project Developer or Eligible Customer's membership and market participation, bridging any concerns or coordination issues with appropriate PJM staff including the respective PJM project managers who oversee the interconnection process.

3.2 PJM Membership

Membership in PJM is granted under the terms of the PJM Operating Agreement. The client manager assigned to each New Service Request will guide each Project Developer or Eligible Customer through this process. While PJM membership is not required for the initial planning and construction phases of a given generation or merchant transmission interconnection project, membership will be required prior to commercial operation. In many cases, such membership will be required in order to integrate operational and market infrastructure with PJM. PJM membership entails certain data requirements, operational and market coordination, committee support and financial obligations.

3.3 Membership in NERC Regional Councils

PJM operates within the geographic boundaries of several regions of the North American Electric Reliability Corporation (NERC), including applicable areas of the ReliabilityFirst and the SERC Reliability Corporation. Any new signatory to the PJM Operating Agreement is obligated to be in compliance with the respective planning, operating and membership requirements of the respective NERC Council in which their facilities are located.

PJM is the registered Balancing Authority (BA), Reliability Coordinator (RC), Transmission Planner (TP), Transmission Service Provider (TSP), Resource Planner (RP), and the Planning



Authority (PA) for its footprint. PJM is also the registered Transmission Operator (TOP) for its footprint except for transmission facilities owned and operated by ITC Interconnection LLC and facilities at or below 138 kV that are owned and operated by American Electric Power.

Section 4: Phases and Decision Points

Section 4 identifies the phases of study and Decision Points for a New Services Request and the reports that will be delivered to the customer upon completion.

4.1 New Service Requests Study Overview

The PJM Operating Agreement, Schedule 6, and the Tariff, Parts VII and VIII describe the procedures used to process New Service Requests for the PJM transmission system. The Operating Agreement and Tariff establish the statutory basis for the business rules, described in detail in this Manual, for the interconnection request process for New Service Requests for the PJM Transmission System. The Cycle process includes three study phases and three Decision Points below:

1. Phase I: Phase I System Impact Study
2. Decision Point I
3. Phase II: Phase II System Impact Study
4. Decision Point II
5. Phase III: Phase III System Impact Study
6. Decision Point III

Each step imposes its own financial obligations and establishes threshold requirements. Projects within each time-based study Cycle are evaluated against a baseline benchmark set of studies in order to establish project-specific responsibility for system enhancements, separate from general Network Upgrades suggested by the results of Regional Transmission Expansion Plan (RTEP) baseline analyses.

Each Project Developer or Eligible Customer is encouraged to participate in the activities of the Transmission Expansion Advisory Committee (TEAC) and its Subregional RTEP Committee. PJM consults with the TEAC and Subregional RTEP Committees as part of the larger Regional Transmission Planning Process through which a coordinated regional expansion plan including expansions necessitated by generation and merchant transmission interconnection is reviewed.

Important PJM interconnection processes established to implement provisions of the PJM Tariff:

- Interconnection Analysis: The interconnection Cycle process including the procedures used to initialize the interconnection evaluation process based on the readiness of all requests received;
- Cost Allocation: The cost responsibility for Network Upgrades required for interconnection;
- Rights: The rights accorded to a Project Developer or Eligible Customer after it has satisfied Tariff requirements;

- **Agreements:** For Project Developers, the required Generation Interconnection Agreement (GIA) or Wholesale Market Participant Agreement (WMPA). The GIA or WMPA is executed by and among three parties: the Project Developer, the Transmission Owner and PJM. A Project Developer may also be subject to additional Construction Service Agreement(s) and/or Network Upgrade Cost Responsibility Agreement(s).

4.2 Overview of System Impact Studies

The Phase I, Phase II and Phase III System Impact Studies are a regional analysis of the effect of adding to the Transmission System the new facilities and services proposed by valid New Service Requests and an evaluation of their impact on deliverability to the aggregate of PJM Network Load.

Procedures and other terms relative to the three study phases are outlined in Tariff Part VII Subpart D, sections 307, 308, 310 and 312 and Tariff Part VIII Subpart C, sections 404, 405, 407, and 409.

4.2.1 General System Impact Study Requirements

1. These studies identify the system constraints, identified with specificity by transmission element or flowgate, relating to the New Service Requests included therein and any resulting Interconnection Facilities, Network Upgrades and/or Contingency Facilities required to accommodate the New Service Requests.
2. These studies provide estimates of cost responsibility and construction lead times for the new facilities required to interconnect the project and system upgrades.
3. PJM, in its sole discretion, can aggregate multiple New Service Requests at the same Point of Interconnection for purposes of Phase I, Phase II and Phase III System Impact Studies. In situations where more than one generation project violates reliability criteria, cost responsibility for Network Upgrades to mitigate such violations will be allocated among the projects in the course of the System Impact Study.

4. The scope of the studies may include:
 - a. an assessment of sub-area import deliverability,
 - b. an assessment of sub-area export deliverability,
 - c. an assessment of project related system stability issues (only occurs in Phase II and Phase III);
 - d. an assessment of project-related short circuit duty issues (only occurs in Phase II and Phase III),
 - e. a contingency analysis consistent with NERC's and each Applicable Regional Entity's reliability criteria and the transmission planning criteria, methods and procedures described in the "FERC Form No. 715 - Annual Transmission Planning and Evaluation Report" for each Applicable Regional Entity,
 - f. an assessment of regional transmission upgrades that most effectively meet identified needs, and
 - g. an analysis to determine cost allocation responsibility for required facilities and upgrades.
5. For purposes of determining necessary Interconnection Facilities and Network Upgrades, these studies shall consider the level of service requested in the New Service Request unless otherwise required to study the full electrical capability of the New Service Request due to safety or reliability concerns.
6. The studies' results shall include the list and facility loading of all reliability criteria violations specific to the New Service Requests.
7. If applicable, the studies for a Transmission Project Developer New Service Request shall also include a preliminary estimate of the Incremental Deliverability Rights associated with the Transmission Project Developer's proposed Merchant Transmission Facilities.

4.2.2 Point of Interconnection

The Point of Interconnection identified by the applicant in the Application Phase will be studied in the Phase I System Impact Study.

4.2.3 Contingent Facilities

PJM may identify Contingent Facilities in the System Impact Studies by reviewing unbuilt Interconnection Facilities and/or Network Upgrades, upon which the New Service Request's cost, timing and study findings are dependent and, if delayed or not built, could cause a need for interconnection restudies of the New Service Request or reassessment of the Network Upgrades.

The method for identifying Contingent Facilities shall be sufficiently transparent to determine why a specific Contingent Facility was identified and how it relates to the New Service Request.

PJM will also include the list of the Contingent Facilities in the System Impact Study(ies) and Generator Interconnection Agreement, including why a specific Contingent Facility was identified and how it relates to the New Service Request.

PJM will also provide, upon request of the Project Developer or Eligible Customer, the estimated Interconnection Facility and/or Network Upgrade costs and estimated in-service completion time of each identified Contingent Facility when this information is readily available and non-commercially sensitive.

4.2.3.1 Minimum Thresholds to Identify Contingent Facilities:

- Load Flow Violations: Load flow violations will be identified based on an impact on an overload of at least five percent distribution factor (DFAX) or contributing at least five percent of the facility rating in the applicable model.
- Short Circuit Violations: Short circuit violations will be identified based on the following criteria: any contribution to an overloaded facility where the New Service Request increases the fault current impact by at least one percent or greater of the rating in the applicable model.
- Stability and Dynamic Criteria Violations: Stability and dynamic criteria violations will be identified based on any contribution to a stability violation.

4.2.4 Facilities Studies

Facilities Studies are performed during the Phase II and Phase III System Impact Studies. The Facilities Study is an engineering study conducted by the affected Transmission Owner(s) to:

1. Determine the required modifications to PJM's Transmission System necessary to implement the conclusions of the System Impact Studies, and;
2. Complete any additional studies or analyses documented in the System Impact Studies or required by PJM Manuals, and determine the required modifications to PJM's Transmission System based on the conclusions of such additional studies.

In the Phase II System Impact Study phase, the Transmission Owner performs the Facilities Study for the Interconnection Facilities required to accommodate the New Service Request. In the Phase III System Impact Study phase, the affected Transmission Owner(s) perform the Facilities Study for any required Network Upgrades.

The Facilities Studies will include good faith estimates of the cost, determined in accordance with Tariff, Part VII, Subpart D, section 307(A)(5) and Part VIII, Subpart D, section 404(A)(7):

(a) To be charged to each affected New Service Customer for the Interconnection Facilities and Network Upgrades that are necessary to accommodate each New Service Request evaluated in the study;

(b) The time required to complete detailed design and construction of the facilities and upgrades, and;

(c) A description of any site-specific environmental issues or requirements that could reasonably be anticipated to affect the cost or time required to complete construction of such facilities and upgrades.

Facilities Study procedures are outlined in Attachment C of this manual.

4.2.5 System Impact Study Results

Results of the each System Impact Study will be publicly posted on the PJM website.

4.2.6 Cost Allocation for Network Upgrades

1. **General:** Each Project Developer and Eligible Customer shall be obligated to pay their designated cost allocation for the required Network Upgrades necessary to accommodate its New Service Request.
2. **Cost Responsibility for Accelerating Network Upgrades included in the Regional Transmission Expansion Plan:** Where the New Service Request calls for accelerating the construction of Network Upgrades that is included in the Regional Transmission Expansion Plan and provided that the party(ies) with responsibility for such construction can accomplish such an acceleration, the Project Developer or Eligible Customer shall pay all costs that would not have been incurred under the Regional Transmission Expansion Plan but for the acceleration of the construction of the upgrade.
3. **Determining the Network Upgrades:** PJM shall determine the minimum amount of Network Upgrades required to resolve each reliability criteria violation in each Cycle, by studying the impact of the projects in the Cycle in their entirety, and not incrementally. Interconnection Facilities and Network Upgrades shall be studied in their entirety and according to the following process:
 - PJM shall identify the New Service Requests in the Cycle contributing to the need for the required Network Upgrades within the Cycle. All New Service Requests that contribute to the need for a Network Upgrade will receive cost allocation for that upgrade pursuant to each New Service Request's contribution to the reliability violation identified on the transmission system in accordance with PJM Manuals.
 - There will be no inter-Cycle cost allocation for Interconnection Facilities or Network Upgrades identified in the System Impact Study costs identified in a Cycle; all such costs shall be allocated to New Service Requests in that Cycle.

4.2.7 Interconnection Facilities

A Project Developer shall be obligated to pay 100 percent of the costs of the Interconnection Facilities necessary to accommodate its Interconnection Request.

“Interconnection Facilities” shall mean the Transmission Owner’s Interconnection Facilities and the Project Developer’s Interconnection Facilities. Collectively Interconnection Facilities include all facilities and equipment between the Generating Facility and the Point of Interconnection, including any modifications, additions, or upgrades that are necessary to physically and electrically interconnect the Generating Facility to the Transmission System.

Interconnection Facilities are sole use facilities and shall not include Distribution Upgrades, Stand Alone Network Upgrades, or Network Upgrades.

4.3 Phase I System Impact Study

After the Application Phase of a Cycle is completed and a group of valid New Service Requests is established, Phase I of a Cycle will commence. During Phase I of a Cycle, PJM shall conduct a Phase I System Impact Study.

The Phase I System Impact Study is conducted on an aggregate basis within a New Services Request’s Cycle, and results are provided in a single Cycle format. The Phase I System Impact Study Results will be publicly available on PJM’s website; Project Developers must obtain the results from the website.

PJM takes the following actions during the Phase I System Impact Study:

1. PJM studies each New Service Request on a summer peak, winter peak and light load RTEP base case. The case year is dependent on the new services cycle under study. PJM will identify the base case year to be used in the study of a specific cycle on its website.
2. PJM will only perform load flow analysis during the Phase I System Impact Study.
3. In Phase I of the Cycle, PJM conducts an Affected System screen to identify any New Service Request with Affected System impacts and provides each Affected System Operator with a list of New Service Request in the Cycle with potential impacts to their respective system.
4. PJM will create both the short circuit and stability base cases to be used in the Phase II System Impact Study.
5. The Phase I System Impact Study results will be publicly available on PJM’s website. Project Developers and Eligible Customers must obtain the results from the website.

Note:

Winter load flow analysis is performed for projects in Transition Cycle #2 and beyond.

The Transmission Owner takes the following actions during the Phase I System Impact Study:

1. Identify required Interconnection Facilities to accommodate the New Service Request.

2. Identify required Network Upgrades to mitigate system violations from the Phase I System Impact Study.
3. Provide planning-level preliminary estimates of Interconnection Facilities and Network Upgrades including scope, cost and elapsed time to complete the work.

Note:

The cost allocation methodology for multiple projects interconnecting to the same substation is described in Attachment B of this manual.

4.3.1 Start and Duration of Phase I System Impact Study

Phase I shall start on the first Business Day immediately following the end of the Application Review phase, but no earlier than 30 days following the distribution of the Phase I Base Case Data. PJM shall use Reasonable Efforts to complete Phase I within 120 calendar days from the date such phase commenced. If the 120th day does not fall on a Business Day, Phase I shall be extended to end on the next Business Day.

If PJM is unable to complete Phase I within 120 calendar days, PJM shall notify all impacted Project Developers and Eligible Customers simultaneously by posting on PJM's website a revised estimated completion date along with an explanation of the reasons why additional time is required to complete Phase I.

During Phase I, and at least 30 days prior to initiating Decision Point I of the Cycle, PJM will post an estimated start date for Decision Point I in order for Project developers and Eligible Customers to prepare to meet their Decision Point I requirements.

4.3.2 Load Flow Analysis

All active New Service Requests, are modeled in the load flow case as appropriate. Summer peak, winter peak and light load base case models will be created for each cycle. Network Upgrades identified for previous cycles will be included in each load flow case.

The load flow Phase I System Impact Study is an AC contingency analysis, NERC P0, P1, P2, P4, P5 & P7 contingencies are tested (see Generator Deliverability section of Manual 14B). Each New Service Request in the Phase I of the System Impact Study will be assigned a commercial probability of 100%. All New Service Requests will be studied as a single group or cluster within the study cycle.

Types of Load Flow Analysis Performed in Phase I System Impact Study

4.3.2.1 Summer and Winter Peak Analysis

PJM performs the generator deliverability test for summer peak and winter peak conditions using their respective base case models. The PJM generation deliverability test is a test

performed in accordance with PJM Manual 14B, section 2.3.10. New Service Requests are subject to the PJM generation deliverability test as applicable.

The PJM load deliverability test is a test performed under stressed summer and winter peak conditions in accordance with PJM Manual 14B, section 2.3.9. The following New Service Requests are subject to the PJM load deliverability test:

- 1) Storage type Generation Interconnection Requests, depending on size and input of an affected Transmission Owner,
- 2) Transmission Interconnection Requests requesting Firm Transmission Withdrawal Rights, and
- 3) Requests for Incremental Capacity Transfer Rights arising from a New Service Request as set forth in Attachment H of this manual.

NERC P3 and P6 “N-1-1” analysis is performed in accordance with PJM Manual 14B, section 2.3.8. New Service Requests are subject to “N-1-1” analysis as applicable. Such applicable examples can include but are not limited to a Generation Interconnection Request that would change system topology, a Transmission Interconnection Request requesting Firm Transmission Withdrawal Rights or Firm Transmission Injection Rights, a Firm Point-to-Point Transmission Service Request, or any New Service Request that changes the system topology due to its required Network Upgrades.

4.3.2.2 Light Load Analysis

PJM also performs Generator Deliverability Analysis for light load conditions (using its respective base case model) in accordance with PJM Manual 14B, section 2.3.10. The light load reliability analysis tests the ability of an electric area to export generation resources to the remainder of PJM during light load conditions.

Transmission Interconnection Requests (Firm Transmission Rights only) and Long Term Firm Point-to-Point Transmission Service requests are also included in the light load reliability analysis for New Service Request studies. The contingencies used for light load reliability analysis include NERC TPL category P1, P2, P4, P5, and P7. NERC TPL P0, normal system conditions is also studied. The Generation Deliverability Test performed during light load reliability analysis is performed in accordance with PJM Manual 14B.

4.3.3 New Service Requests associated with PARs and other Controllable AC

Phase angle regulators (PAR), also called phase shifting transformers, create a phase shift between primary (source) and secondary (load) side of the device to control the amount of flow through the facility. These devices may be proposed to serve as Controllable A.C. Merchant Transmission Facilities under the Tariff. Inherent to these devices are certain operational characteristics that must be addressed to confirm acceptability of the design and incorporation of the proposed facility in the PJM system.

In order to ensure that the facility does not cause excessive upset to the system in the area of the proposed facility, it is recommended that the initial step size of the facility's output not exceed a quantity of 20MWs, when initially transitioning from zero flow to some specified MW value. Initial output quantities in excess of 20 MWs are studied to determine the impacts to the other facilities near the proposed facility to determine if the initial MW quantity, in excess of 20 MWs, would cause a problem to occur. The study of the impacts associated with this initial step size will begin during the System Impact Study Phase I of the projects development. If any issues are identified, associated with a step size in excess of 20 MWs, which cannot be resolved, then the customers Interconnection Request will be withdrawn from the Cycle.

The controls associated with a PAR must be capable of providing automatic control so that the scheduled MW quantity for the facility is maintained for all contingency conditions that are required to be tested dependent on the type of service requested whether it be capacity or energy injection or firm or non-firm withdrawal rights. Deviations from the scheduled MW quantity can result in charges to the facility as governed by PJM market rules. Beyond automatic control of the facility, the proposed facility controls must allow for a manual mode of operation to hold the angle of the PAR as opposed to maintaining the MW flow in the event this mode of operation is requested by PJM Operations during periods of system upset or emergency. Additionally, the proposed customer facility must be capable of achieving zero flow through the design of the facility by the customer. One other example of AC controlled facilities are Variable Frequency Transformers.

4.3.4 HVDC and other Alternate Technology Projects

In addition to the studies normally required during the System Impact Study phases for interconnection and integration of a project in PJM, several additional studies may be required among PJM, Transmission Owner(s), and the Transmission Project Developer to facilitate the proper design of an HVDC or other alternate technology facility. PJM and member Transmission Owners require verification of the expected performance of the facilities being interconnected. HVDC additional study requirements are in Attachment D.

4.3.5 Phase I System Impact Study Results

PJM will publicly post results in a single Cycle format on the PJM website.

After reviewing the results of the Phase I System Impact Study, the Project Developer must decide whether or not to move forward to Phase II of the process in Decision Point I to remain in the Cycle.

A New Service Request may qualify to accelerate to a final interconnection related agreement (located in Tariff, Part IX), if it meets the requirements identified in Tariff, Part VII, Subpart D, section 309(A)(2) or Tariff, Part VIII, Subpart C, section 406(A)(2).

4.4 Decision Point I

Decision Point I commences on the first Business Day immediately following the end of Phase I and closes 30 calendar days later. However, if the 30th day does not fall on a Business Day then this period shall conclude on the next Business Day. New Service Requests that are studied in Phase I will enter Decision Point I. Before the close of Decision Point I, the Project Developer or Eligible Customer can choose to either remain in the Cycle by meeting the Decision Point I requirements or to withdraw its New Service Request. A project that PJM determines qualifies to accelerate to a final interconnection related agreement must meet the acceleration provisions of the Tariff, Part VII, Subpart D, section 309(A)(2) or Tariff, Part VIII, Subpart C, section 406(A)(1).

New Service Requests not eligible to accelerate to a final interconnection related agreement must provide the following requirements in order to remain in the Cycle:

1. The applicable Readiness Deposit No. 2
2. For Project Developers only: Evidence of Site Control consistent with requirements outlined in Section 7 of this manual.
3. For Transmission Interconnection Requests only: Evidence acceptable to PJM that Project Developer has submitted and maintained a valid corresponding interconnection request with any required adjacent control area(s) in which it is interconnecting or is required to interconnection with as part of their Transmission Interconnection Request.
4. Project Developer shall maintain its interconnection request positions with such adjacent Control Area(s) throughout the entire PJM Transmission Interconnection Request process for the relevant PJM Transmission Interconnection Request.
5. Evidence of air and water permits (if applicable).
6. For State level, non-FERC jurisdictional projects only: Evidence of participation in state interconnection process with appropriate entity (e.g. Electric Distribution Company or Cooperative).
7. Submission of data via PJM data submission tool as required for Phase II System Impact Study.

Note:

If Project Developer or Eligible Customer fails to submit all required deposits, evidence, and data before the close of Decision Point I, the New Service Request will be terminated and withdrawn.

4.4.1 Decision Point I Deficiency Review

Once all of the above elements are received, PJM will proceed with deficiency review of evidence and data provided at the close of Decision Point I.

PJM will use Reasonable Efforts to review submitted evidence and data within ten Business Days after the close of Decision Point I and the Project Developer or Eligible Customer will have five Business Days to respond to the deficiency.

PJM will exercise Reasonable Efforts to review response within ten Business Days and then will either terminate and withdraw the project, if the above requirements are not met or PJM will include the New Service Request in Phase II System Impact Study.

PJM's review of the above required elements may run co-extensively with Phase II.

4.4.2 Readiness Deposit No. 2

Readiness Deposit No. 2 is in addition to Readiness Deposit No. 1. It will be calculated by PJM during Phase I and will not be reduced or refunded due to subsequent New Service Request modifications or cost allocation changes. Section 6 of this manual provides more detail on the required Readiness Deposits.

4.4.3 Acceleration at Decision Point I

Only New Service Requests that have no cost allocation for Network Upgrades and do not require further studies are eligible for acceleration. Upon completion of the Phase I System Impact Study, PJM may accelerate treatment of such New Service Request.

Refer Decision Point III section of this manual for final agreement requirements. Tariff Part VII, Subpart D, section 309(A)(2) and Tariff Part VIII Subpart C, section 406(A)(2) outline the Project Developer or Eligible Customer requirements for accelerated treatment of the New Service Request.

4.4.4 Project Withdrawal at Decision Point I

There are two conditions under which a project would be withdrawn at Decision Point I:

1. A Project Developer or Eligible Customer decides to withdraw at Decision Point I. In this case, PJM must receive notification in writing prior to the close of the Decision Point I.
2. PJM deems the New Service Request terminated and withdrawn for failing to meet any of the Decision Point I requirements.

In either case, PJM will:

1. Remove the New Service Request from the Cycle.

2. Readiness Deposits will be treated pursuant to Tariff Part VII, Subpart A, section 301(A)(3)(b)(iii) , Part VII, Subpart D, Section 309 (A)(4), Part VIII, Subpart A, section 401(D)(2)(c) and Part VIII, Subpart C, Section 406(A)(4).
 - a. Readiness Deposits for Project Developers in Transition Cycle No. 1 will be treated as follows:
 - i. PJM will initiate the process of refunding 100% of Readiness Deposit No. 1 at the close of the PJM Decision Point I deficiency review.
 - ii. If payment has already been made, PJM will initiate the process of refunding 100% of Readiness Deposit No. 2 at the close of the PJM Decision Point I deficiency review.
 - b. Readiness Deposits for Project Developers in Transition Cycle No. 2 and beyond will be treated as follows:
 - i. PJM will initiate the process of refunding 50% of Readiness Deposit No. 1 at the close of the PJM Decision Point I deficiency review.
 - ii. If payment has already been made, PJM will initiate the process of refunding 100% of Readiness Deposit No. 2 at the close of the PJM Decision Point I deficiency review.
 - iii. PJM will initiate the process of refunding up to 50% of the remaining Readiness Deposit No. 1 at the close of the Cycle.
3. At the conclusion of the deficiency review for Decision Point I, PJM will initiate the process to refund to the Project Developer or Eligible Customer up to 90 percent of its Study Deposit submitted with its New Service Request during the Application Phase, less any actual costs.

4.4.5 New Service Request Modifications Allowed at Decision Point I

Modifications that are permitted at Decision Point I are outlined in this manual in Section 9.

Project Developers or Eligible Customers must provide updated modeling data at Decision Points I and II for any changes to the New Service Request as follows:

1. Stability: An updated dynamic model submission shall be provided in the data submission tool.
2. Short Circuit: Updated data required via data submission tool.
3. Load Flow: Updated data required via data submission tool.

4.5 Phase II System Impact Study

After the Decision Point I phase of a Cycle is completed and a group of valid New Service Requests is established, Phase II of a Cycle will begin. During Phase II of a Cycle, PJM will perform the Phase II System Impact Study. Only New Service Requests meeting the

requirements of Tariff, Part VII, Subpart D, section 309 or Tariff, Part VIII, Subpart C, section 406, Decision Point I phase, will be included in the Phase II System Impact Study.

PJM takes the following action during the Phase II System Impact Study:

1. PJM will retool load flow results from Phase I System Impact Study (summer peak, winter peak and light load) based on decisions made by Project Developers or Eligible Customers during Decision Point I.
2. PJM will conduct any required voltage analyses.
3. PJM will perform short circuit and stability analyses as required.
4. PJM will coordinate with the Affected System to confirm which projects in PJM Cycle will require Affected System studies. If the Affected System Operator indicates that an Affected System study is required, PJM will:
 - a. Notify the Project Developer or Eligible Customer of the need for an Affected System study and the requirement to execute an Affected System study agreement with the impacted Affected System Operator, and;
 - b. Include the results of the Affected System Operator's Affected System Study in the Phase II System Impact Study results, if applicable and available.
5. The Phase II System Impact Study Results will be publicly available on PJM's website. Project Developers and Eligible Customers must obtain the results from the website.

The Transmission Owner takes the following action during the Phase II System Impact Study:

1. Verify Interconnection Facilities and Network Upgrades required to accommodate the New Service Request.
2. Perform a Facilities Study. The Facilities Study in Phase II System Impact Study phase will be for the physical Interconnection Facilities. The Facilities Study requirements are outlined in Attachment C of this manual. The study will be conducted pursuant to Tariff, Part VII, Subpart D, section 307(A)(7) and Tariff, Part VIII, Subpart C, section 404(A)(7).

4.5.1 Start and Duration of Phase II System Impact Study

Phase II System Impact Study will start on the first Business Day immediately following the end of the Decision Point I unless the Decision Point III of the immediately preceding Cycle is still open. In no event shall Phase II of a Cycle begin before the conclusion of the Decision Point III Phase of the immediately preceding Cycle.

PJM shall use Reasonable Efforts to complete Phase II within 180 days from the start date of Phase II. If the 180th day does not fall on a Business Day, Phase II shall be extended to end on the next Business Day.

If PJM is unable to complete Phase II within 180 days, PJM shall notify all impacted Project Developers simultaneously by posting on PJM's website a revised estimated completion date along with an explanation of the reasons why additional time is required to complete Phase II.

4.5.2 Voltage Analysis

Voltage analysis is performed in accordance with PJM Manual 14B, section 2.3.7. New Service Requests are subject to steady-state voltage analysis as determined by PJM following consideration of project specific characteristics including but not limited to request type, fuel type, operational modes, location, configuration and project size.

4.5.3 Short Circuit Analysis

All New Service Requests are subject to evaluation as to the need for short circuit analysis. The case year used for the study of the fault contributions associated with a New Service Request shall be consistent with the case used in the thermal analysis studies. Short circuit analysis shall be performed consistent with the requirements of section G.7 of Attachment G to PJM Manual 14B.

4.5.4 Stability Analysis

All New Service Requests are subject to evaluations to determine the need for stability analysis and/or review which will be performed during the Phase II System Impact Study. Stability analysis is performed as described in PJM Manual 14B Attachment G. Similar to the powerflow analysis performed during the Phase II System Impact Study, a stability analysis can also include different sets of analyses at various load levels such as summer peak and/or light load. An overview of the stability analysis activities in a Cycle is provided in the table below.

Note:

Project Developers or Eligible Customers shall follow PJM Dynamic Model Development Guidelines on PJM website to submit dynamic model data specific to their project. Any Dynamic model data submission that is not in accordance with the PJM Dynamic Model Development Guidelines will be deemed deficient.

Phase	Activity
Application Phase	The applicant submits stability data and PJM reviews submission.
Phase I	PJM builds the stability case.
Decision Point I	Project Developer or Eligible Customer shall provide an updated dynamic model submission for any change to the project using the PJM data submission tool.
Phase II	PJM performs stability studies.
Decision Point II	Project Developer or Eligible Customer shall provide an updated dynamic model submission for any

	change to the project using the PJM data submission tool.
Phase III	PJM performs re-studies as necessary to accommodate changes made at Decision Point II.
Decision Point III	No Project Developer or Eligible Customer changes are permitted.
Final Agreement and Negotiation	PJM performs re-studies as necessary to accommodate changes made at Decision Point III in order to confirm need for any identified Network Upgrades prior to tendering final draft of final agreements.

Exhibit 8: Stability Analysis Activities in a Cycle

4.5.5 Facilities Study for Interconnection Facilities

The Phase II System Impact Study will include a Facilities Study by the affected Transmission Owner for the physical Interconnection Facilities. The Phase III System Impact Study will include a Facilities Study by the affected Transmission Owner for any required Network Upgrades.

The Facilities Studies will include good faith estimates of the cost, determined in accordance with Tariff, Part VII, Subpart 307(A)(7) and Tariff, Part VIII, Subpart C, section 404(A)(7),

1. to be charged to each affected New Service Customer for the Interconnection Facilities and Network Upgrades that are necessary to accommodate each New Service Request evaluated in the study;
2. the time required to complete detailed design and construction of the facilities and upgrades;
3. a description of any site-specific environmental issues or requirements that could reasonably be anticipated to affect the cost or time required to complete construction of such facilities and upgrades.

The Facilities Study will document the engineering design work necessary to begin construction of any required transmission facilities, including estimating the costs of the equipment, engineering, procurement and construction work needed to implement the conclusions of the System Impact Study in accordance with Good Utility Practice and, when applicable, identifying the electrical switching configuration of the connection equipment, including without limitation: the transformer, switchgear, meters, and other station equipment; and the nature and estimated costs of Interconnection Facilities and Network Upgrades necessary to accommodate the New Service Request.

For purposes of determining necessary Interconnection Facilities and Network Upgrades, the Facilities Study will consider the level of Interconnection Service requested by the Project Developer unless otherwise required to study the full electrical capability of the Generating Facility or Merchant Transmission Facility due to safety or reliability concerns. The Facilities Study will also identify any potential control equipment for requests for Interconnection Service that are lower than the full electrical capability of the Generating Facility or Merchant Transmission Facility.

4.6 Decision Point II

Decision Point II commences on the first Business Day following the end of Phase II and closes 30 calendar days later. However, if the 30th day does not fall on a Business Day, this time period shall conclude on the next Business Day. New Service Requests studied in Phase II will enter Decision Point II. Before the close of Decision Point II, the Project Developer or Eligible Customer can choose to either remain in the Cycle or to withdraw its New Service Request. A project that PJM qualifies to accelerate to a final interconnection related agreement must meet the acceleration provisions of the Tariff, Part VII, Subpart D, section 311(A)(2)(d) or Tariff, Part VIII, Subpart C, section 408(A)(2)(d).

New Service Requests not eligible to accelerate to a final interconnection related agreement must provide the following requirements in order to remain in the Cycle:

1. Readiness Deposit No. 3.
2. Notification in writing that Project Developer elects to exercise the Option to Build for Stand Alone Network Upgrades with respect to its New Service Request.
3. Evidence of air and water permits (if applicable).
4. State level, non-FERC jurisdictional projects only: Evidence of participation in state interconnection process with appropriate entity (e.g. Electric Distribution Company or Cooperative).
5. Submission of New Service Request data as required for Phase III System Impact Study.
6. Evidence that Project Developer or Eligible Customer has entered into an executed Affected System Study Agreement (If required) by the later of Decision Point II or 60 days after PJM notifies the developer that an Affected System Study Agreement is required.
7. Transmission Interconnection Requests only: Evidence acceptable to PJM that Project Developer has submitted and maintained a valid corresponding interconnection request with any required adjacent control area(s) in which it is interconnecting or is required to interconnection with as part of their Transmission Interconnection Request.

Note:

If Project Developer or Eligible Customer fails to submit all required deposits, evidence, and data before the close of Decision Point II, the New Service Request will be terminated and withdrawn. There are no Site Control requirements at Decision Point II.

4.6.1 Decision Point II Deficiency Review

Once all of the above elements are received, PJM will proceed with deficiency review of evidence and data provided at the close of Decision Point II. PJM will use Reasonable Efforts to review submitted evidence and data within ten Business Days after the close of Decision Point II and the Project Developer or Eligible Customer will have five Business Days to respond to the deficiency.

PJM will exercise Reasonable Efforts to review the response within ten Business Days and then PJM will either terminate and withdraw the project if the above requirements are not met, or include the New Service Request in Phase III System Impact Study.

PJM's review of the above-required elements may run co-extensively with Phase III.

4.6.2 Readiness Deposit No. 3

Readiness Deposit No. 3 is in addition to Readiness Deposit No. 1 and Readiness Deposit No. 2. It will be calculated by PJM during Phase II and will not be reduced or refunded based upon subsequent New Service Request modifications or cost allocation changes. Section 6 of this manual provides more detail on the required Readiness Deposits.

4.6.3 Acceleration at Decision Point II

Only New Service Requests that have no cost allocation for Network Upgrades and do not require further studies are eligible for acceleration. Upon completion of the Phase II System Impact Study, PJM may accelerate treatment of such New Service Request. Tariff Part VII, Subpart D, section 311 (A)(2)(d) and Tariff Part VIII Subpart C, section 408(A)(2)(d) outline the Project Developer or Eligible Customer requirements for accelerated treatment of the New Service Request.

4.6.4 Project Withdrawal at Decision Point II

There are two conditions under which a project would be withdrawn at Decision Point II:

1. A Project Developer or Eligible Customer decides to withdraw at Decision Point II. In this case, PJM must receive notification in writing prior to the close of the Decision Point II.
2. PJM deems the New Service Request terminated and withdrawn for failing to meet any of the Decision Point II requirements, as set forth in Tariff, Part VII, Subpart D, section 311 and Tariff, Part VIII, Subpart C, section 408.

In either case, PJM will:

1. Remove the New Service Request from the Cycle.
2. Readiness Deposits will be treated pursuant to Tariff, Part VII, Subpart A, section 301(A)(3)(b)(iii), Part VII, Subpart D, Section 311 (B)(3), Part VIII, Subpart A, section 401(D)(2)(c) and Part VIII, Subpart B, Section 408(B)(3).
 - a. At the conclusion of the deficiency review for Decision Point II, PJM will initiate the process of refunding 100% of Readiness Deposit #2.
 - b. PJM will initiate the process of refunding up to 100% of Readiness Deposit 1 at the close of the Cycle.
 - c. Adverse Study Impact: PJM will refund the Project Developer or Eligible Customer the cumulative Readiness Deposit amounts paid at the Application Phase and Decision Point I Phase if the Network Upgrade cost from Phase I to Phase II:
 - i. Increases overall by 25% or more, and
 - ii. Increases by more than \$10,000 per MW.
 - iii. Network Upgrade costs shall include costs identified in Affected System studies in their respective phases.
3. At the conclusion of the deficiency review for Decision Point II, PJM will initiate the process to refund to the Project Developer or Eligible Customer up to 90 percent of its Study Deposit submitted with its New Service Request during the Application Phase, less any actual costs.

4.6.5 New Service Request Modifications Allowed at Decision Point II

Modifications which are permitted at Decision Point II are outlined in this manual in Section 9.

4.7 Phase III System Impact Study

After the Decision Point II of a Cycle is completed and a group of valid New Service Requests is established, Phase III of a Cycle will begin. During Phase III of a Cycle, PJM will perform the Phase III System Impact Study. Only New Service Requests meeting the requirements of Tariff, Part VII, Subpart D, section 311 or Tariff, Part VIII, Subpart C, section 408, Decision Point II, will be included in the Phase III System Impact Study.

PJM takes the following action during the Phase III System Impact Study:

1. PJM will retool load flow, short circuit and stability results based on decisions made by Project Developers or Eligible Customers during Decision Point II.
2. PJM will coordinate with Affected System Operators to conduct any studies required to determine the final impact of a New Service Request on any Affected System and will include the final Affected System Study results in the Phase III System Impact Study, if available from the Affected System.

3. The Phase III System Impact Study Results will be publicly available on PJM's website; Project Developers and Eligible Customers must obtain the results from the website.
4. PJM will tender draft final agreements to Project Developers or Eligible Customers.

The Transmission Owner takes the following action during the Phase III System Impact Study:

1. Verify Interconnection Facilities and Network Upgrades required to accommodate the New Service Request.
2. Perform a Facilities Study. The Facilities Study in Phase III System Impact Study will be for the Network Upgrades. The Facilities Study requirements are outlined in Attachment C of this manual. The study will be conducted pursuant to Tariff, Part VII, Subpart D, section 307 and Tariff, Part VIII, Subpart C, section 404(A)(7).

4.7.1 Start and Duration of Phase III System Impact Study

Phase III System Impact Study will start on the first Business Day immediately following the end of the Decision Point II unless the Final Agreement Negotiation Phase of the immediately preceding Cycle is still open. In no event shall Phase III of a Cycle begin before the conclusion of the Final Agreement Negotiation Phase of the immediately preceding Cycle.

PJM shall use Reasonable Efforts to complete Phase III within 180 days from the start date of Phase III. If the 180th day does not fall on a Business Day, Phase III shall be extended to end on the next Business Day. If PJM is unable to complete Phase III within 180 days, PJM shall notify all impacted Project Developers simultaneously by posting on PJM's website a revised estimated completion date along with an explanation of the reasons why additional time is required to complete Phase III.

4.7.2 Draft Final Agreement

Prior to the Final Agreement Negotiation Phase, PJM will provide in electronic form a draft interconnection related agreement from Tariff, Part IX, as applicable to the Project Developer's or Eligible Customer's New Service Request, along with any applicable draft schedules, to the parties to such interconnection related agreement.

4.8 Decision Point III

Decision Point III commences on the first Business Day following the end of Phase III and runs concurrently with the Final Agreement Negotiation Phase. New Service Requests studied in Phase III will enter Decision Point III. Before the close of Decision Point III, the Project Developer or Eligible Customer can choose to either remain in the Cycle or to withdraw its New Service Request.

Note:

New Service Requests may not be changed or modified in any way for any reason during Decision Point III.

PJM must receive from the Project Developer or Eligible Customer all of the following required elements for before the close of Decision Point III for a New Service Request to remain in the Cycle and proceed through the Final Agreement Negotiation phase:

1. Security: Security will be calculated for New Service Requests based on the Network Upgrade costs allocated pursuant to the Phase III System Impact Study results.
2. Notification in writing that the Project Developer or Eligible Customer elects to proceed to final agreement with respect to its New Service Request.
3. Site Control: Evidence of Site Control consistent with requirements outlined in Section 7 of this manual, Tariff Part VII, Subpart A Section 302 and Tariff Part VIII Subpart A, Section 402. Specifically, a Project Developer must supply Site Control evidence of 100 percent Site Control for the Generating Facility or Merchant Transmission Facility for the identified required Interconnection Switchyard, with the proviso that the Project Developer can provide this Site Control within 180 days of execution of the final interconnection-related service agreement if certain conditions are met.
4. Transmission interconnection requests only: Evidence acceptable to PJM that Project Developer has submitted and maintained a valid corresponding interconnection request with any required adjacent control area(s) in which it is interconnecting or is required to interconnection with as part of their Transmission Interconnection Request.
5. Evidence of the following:
 - a. Fuel delivery agreement or water agreement (if necessary) and control of Right of Way for fuel and water interconnections
 - b. Any necessary local, county, and state site permits
 - c. Signed a memorandum of understanding (MOU) for acquisition of major equipment.
6. State level, non-FERC jurisdictional projects only: Evidence fully executed Interconnection Agreement with applicable entity (e.g. Electric Distribution Company or Cooperative)

Note:

If Project Developer or Eligible Customer fails to submit all required deposits, evidence, and data before the close of Decision Point III, the New Service Request will be terminated and withdrawn.

If Project Developer or Eligible Customer does not satisfy the requirements for fuel or water agreement, permits, and MOU, these requirements can be addressed through a milestone in the applicable interconnection-related service agreement entered into pursuant to Tariff, Part IX.

4.8.1 Decision Point III Deficiency Review

Once all of the above elements are received, PJM will proceed with deficiency review of evidence and data provided at the close of Decision Point III. PJM will use Reasonable Efforts to review submitted evidence and data within ten Business Days after the close of Decision Point III and the Project Developer or Eligible Customer will have five Business Days to respond to the deficiency.

PJM will exercise Reasonable Efforts to review the response within ten Business Days and then PJM will either terminate and withdraw the project, if the above requirements are not met, or the project will remain in the Final Agreement Negotiation Phase.

4.8.2 Project Withdrawal at Decision Point III

There are two conditions under which a project would be withdrawn at Decision Point III:

1. A Project Developer or Eligible Customer decides to withdraw at Decision Point III. In this case, PJM must receive notification in writing prior to the close of the Decision Point III.
2. PJM deems the New Service Request terminated and withdrawn for failing to meet any of the Decision Point III requirements, as set forth in Tariff, Part VII, Subpart D, section 313 and Tariff Part VIII, Subpart C, section 410.

In either case, PJM will:

1. Remove the New Service Request from the Cycle.
2. Readiness Deposits will be treated pursuant to Tariff Part VII, Subpart A, section 301(A)(3)(b)(iii), Part VII, Subpart D, section 313(B), Part VIII, Subpart A, section 401(D)(2) and Part VIII, Subpart B, section 410(B).
 - a. Adverse Study Impact: PJM will refund the Project Developer or Eligible Customer the cumulative Readiness Deposit Nos. 1, 2 and 3 paid by the Project Developer or Eligible Customer if the Network Upgrade cost from Phase II to Phase III:
 - i. Increases overall by 35% or more; and
 - ii. Increases by more than \$25,000 per MW.
 - iii. Network Upgrade costs shall include costs identified in Affected System studies in their respective phases.
3. At the conclusion of the deficiency review for Decision Point III, PJM will initiate the process to refund to the Project Developer or Eligible Customer up to 90 percent of its Study Deposit submitted with its New Service Request during the Application Phase, less any actual costs.

4.8.3 New Service Request Modifications Not Allowed at Decision Point III

No modifications to New Service Requests are permitted at Decision Point III.

4.9 New Service Request Connection Types

New Service Requests can interconnect to the PJM system in various ways including via a new interconnection switchyard, a tap into an existing substation or a tap off of an existing line. This section provides one line diagrams of the different interconnection arrangements and includes descriptions of the facilities associated with such an interconnection.

Each individual Transmission Owner has technical requirements for interconnection onto their system. Refer to the Transmission Owner Engineering & Construction Standards on PJM’s website for the latest requirements for transmission-connected facilities for each Transmission Owner in the PJM footprint.

4.9.1 Generator Interconnection via New Interconnection Switchyard

Exhibit (Generator Interconnection via New Interconnection Switchyard) depicts a generator interconnecting to a transmission line for which the Transmission Owner requires an interconnection switchyard to accommodate the connection.

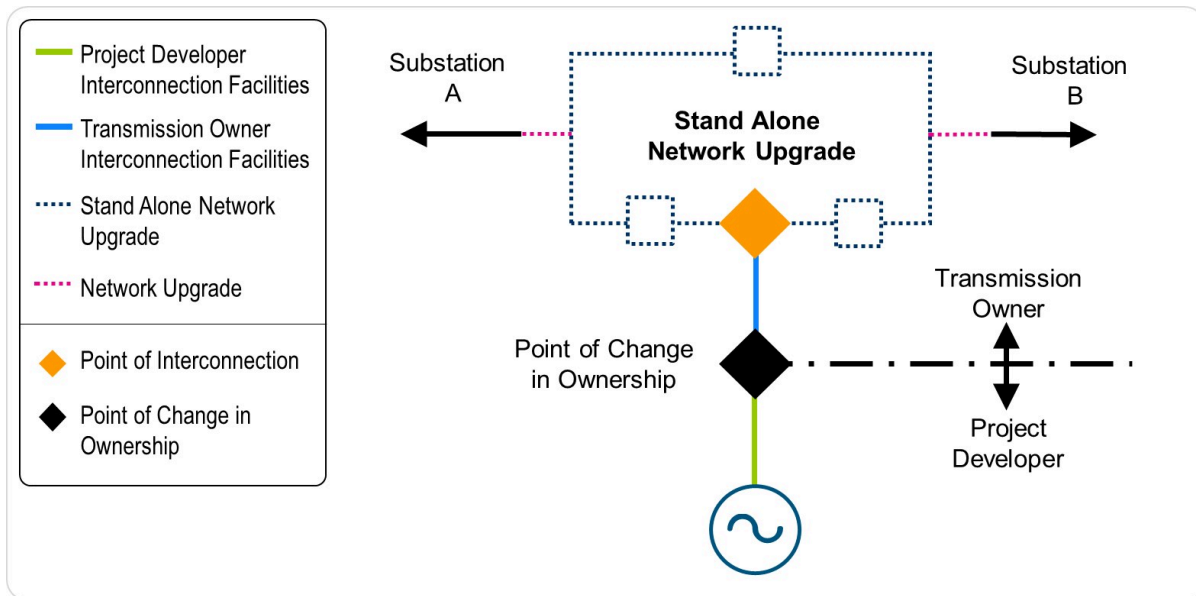

Exhibit 9: Generator Interconnection via New Interconnection Switchyard

4.9.2 Generator Interconnection into Existing Transmission Owner’s Substation

Exhibit (Generator Interconnection into Existing TO Substation) depicts a generator interconnecting to an existing Transmission Owner substation which needs to be expanded to accommodate the interconnection.

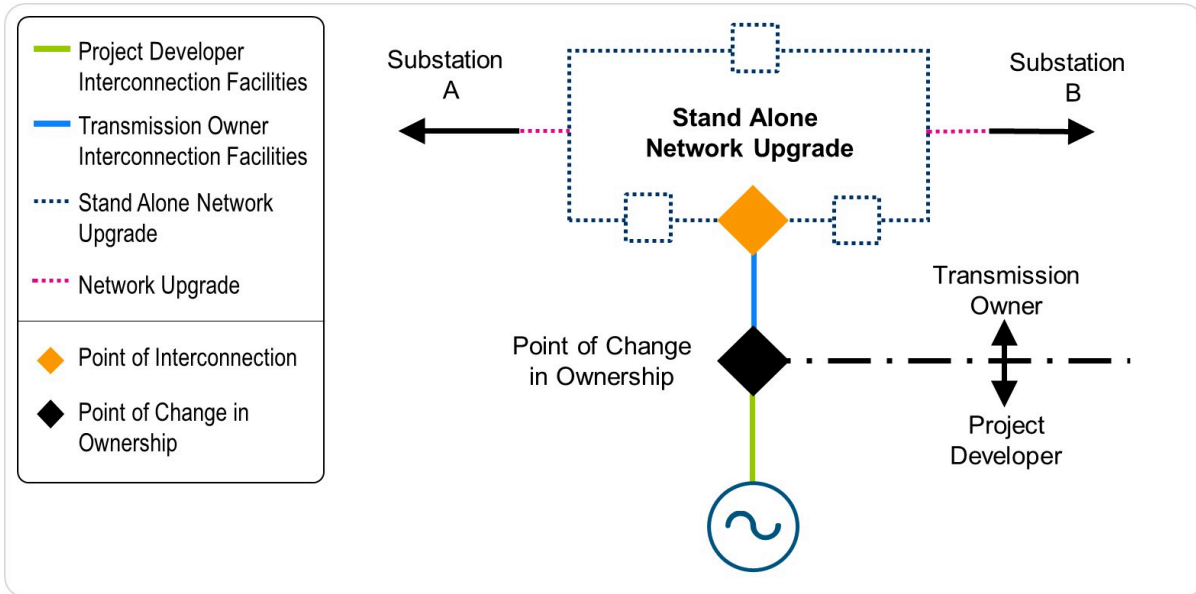

Exhibit 10: Generator Interconnection into Existing TO Substation

4.9.3 Generator Interconnection as a Tap off of an Existing Line

Exhibit (Generator Interconnection as a Tap off of an Existing Line) depicts a generator interconnecting to tap off of an existing line for which the Transmission Owner does not require an interconnection switchyard.

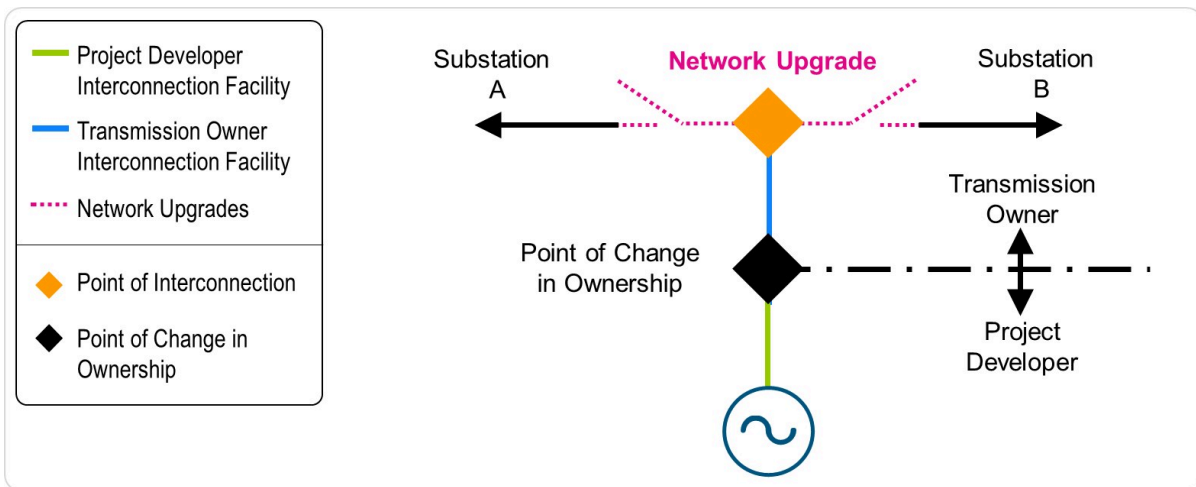

Exhibit 11: Generator Interconnection as a Tap off of an Existing Line

4.9.4 Generator Interconnection to a Non-FERC Facility

Exhibit (Generator Interconnection to a Non-FERC Facility) depicts a generator interconnecting to a non-FERC jurisdictional facility such as a cooperative (coop) or municipality (muni).

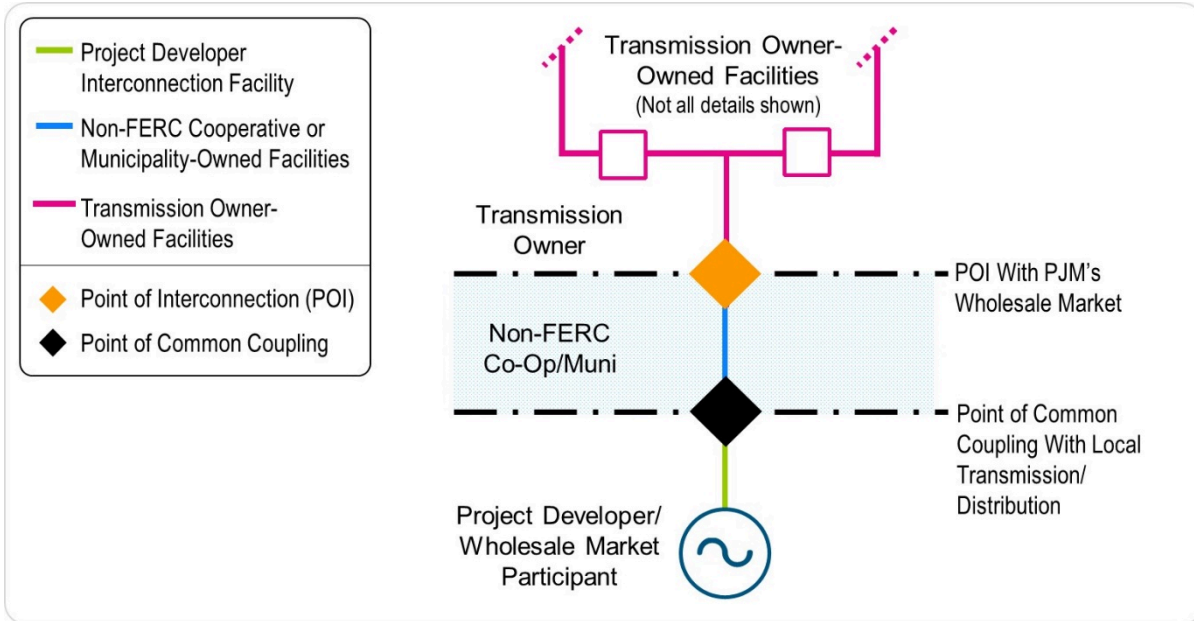

Exhibit 12: Generator Interconnection to a Non-FERC Facility

4.9.5 Merchant Transmission Interconnection

Exhibit (Merchant Transmission Interconnection) provides an example of a merchant transmission interconnection. In this example, a new Phase Angle Regulator (PAR) is being proposed near an existing substation with the New Service Request. The PAR is tied between PJM's system and a neighboring ISO in this example.

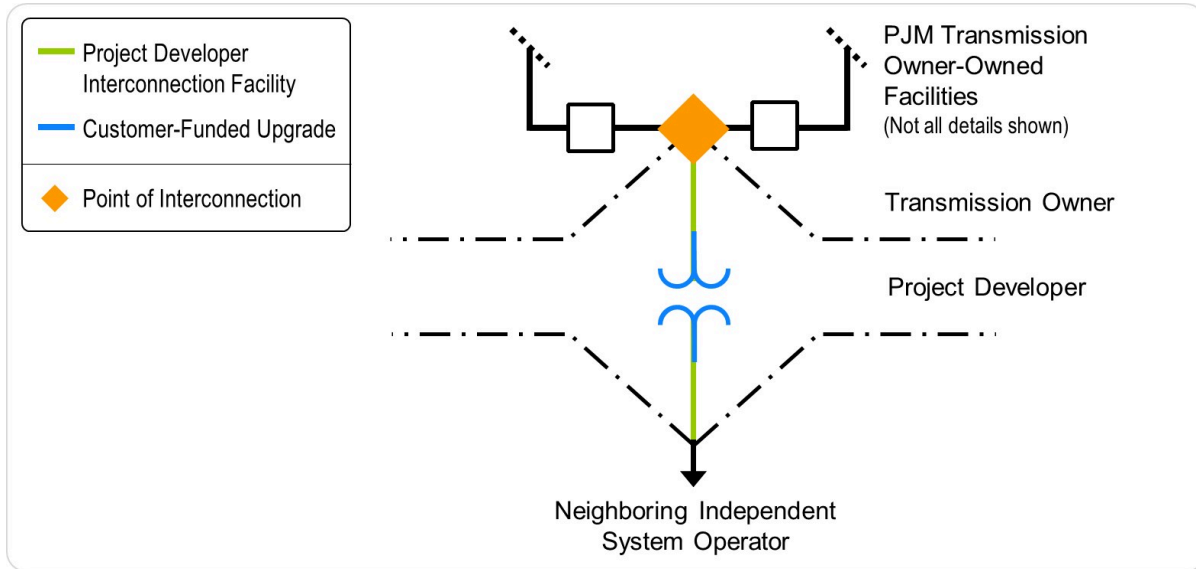

Exhibit 13: Merchant Transmission Interconnection

4.9.6 Description of Diagram Components

4.9.6.1 Generating Facility:

A Generating Facility is the Project Developer’s device for the production and/or storage for later injection of electricity identified in the New Service Request. The Generating Facility does not include the Project Developer’s Interconnection Facilities. A Generating Facility consists of one or more generating unit(s) and/or storage device(s), which usually can operate independently and be brought online or taken offline individually.

4.9.6.2 Interconnection Facilities:

Interconnection Facilities include all facilities and equipment between the Generating Facility and the Point of Interconnection, including any modifications, additions, or upgrades that are necessary to physically and electrically interconnect the Generating Facility to the Transmission System. Interconnection Facilities shall mean the Transmission Owner’s Interconnection Facilities and the Project Developer’s Interconnection Facilities.

4.9.6.3 Project Developer Interconnection Facilities:

Project Developer Interconnection Facilities are all facilities and equipment owned and/or controlled, operated and maintained by Project Developer on Project Developer’s side of the Point of Change of Ownership.

4.9.6.4 Point of Change in Ownership:

Point of Change in Ownership is where the Project Developer's Interconnection Facilities connect to the Transmission Owner's Interconnection Facilities.

4.9.6.5 Transmission Owner Interconnection Facilities:

Transmission Owner Interconnection Facilities are all facilities owned, controlled, operated and maintained by the Transmission Owner from the Transmission Owner's side of the Point of Change of Ownership to the Point of Interconnection.

4.9.6.6 Point of Interconnection:

Point of Interconnection is the point or points where the Interconnection Facilities connect with the Transmission System.

4.9.6.7 Network Upgrades:

Network Upgrades are modifications or additions to transmission-related facilities that are integrated with and support PJM's overall Transmission System for the general benefit of all users of such Transmission System.

4.9.6.8 Common Use Upgrade:

Common Use Upgrade (CUU) is a Network Upgrade that is needed for the interconnection of Generating Facilities or Merchant Transmission Facilities of more than one Project Developer or Eligible Customer and which is the shared responsibility of each Project Developer or Eligible Customer. The affected Project Developers or Eligible Customers will be parties to the NUCRA which will define their cost responsibility for the CUU.

4.9.6.9 Customer-Funded Upgrade:

Customer-Funded Upgrade is any Network Upgrade, Distribution Upgrade, or Merchant Network Upgrade for which cost responsibility (i) is imposed on a Project Developer or Eligible Customer, or (ii) is voluntarily undertaken by an Upgrade Customer in fulfillment of an Upgrade Request.

4.9.6.10 Distribution Upgrades:

Distribution Upgrades are additions, modifications, and upgrades to the Distribution System at or beyond the Point of Interconnection to facilitate interconnection of the Generating Facility.

4.9.6.11 Stand Alone Network Upgrades:

Stand Alone Network Upgrades shall mean Network Upgrades which a Project Developer or Transmission Owner may construct without affecting day-to-day operations (e.g. taking a transmission outage) of the Transmission System during their construction.

4.10 Other Related Studies Performed

4.10.1 Interim Deliverability Studies

4.10.1.1 Applicability

PJM performs interim deliverability studies for two reasons:

1. Projects that request to come into service prior to the base case study year in which they are studied and
2. Projects that request to come into service prior to the construction of a required Contingent Facilities. Contingent Facilities are identified in the latest System Impact Study or in either (i) Specifications, section 3.d or (ii) Schedule F of the GIA or ISA. Contingent Facilities may be Network Upgrades, baseline upgrades, or Supplemental Project upgrades.

These studies are performed in order to determine whether a project is deliverable for all or a portion of its output.

4.10.1.2 Schedule for Interim Deliverability Studies

Notwithstanding Tariff Part VII, Subpart E, section 327 and Tariff Part VIII, Subpart E, section 425, Project Developers that request an Interim Deliverability Study under these provisions, agree to waive their rights to confidential treatment of such requests and further agree that requests inclusive of project name, location, Project Identifier and requested study output megawatt for interim deliverability studies for a particular Delivery Year shall be made a minimum of eleven months prior to the start of that Delivery Year and will be publicly posted. PJM will only consider projects for interim deliverability analysis if a Project Developer initiates a request to be studied for a particular Delivery Year. PJM intends to provide interim deliverability results eight months prior to the start of the Delivery Year.

4.10.1.3 Analysis for Interim Deliverability Studies

The interim deliverability study evaluates the system availability differently depending on the reason for the interim study. Projects requesting to come into service prior to the base case study year in which they were originally studied are evaluated against all violations. Projects that request to come into service prior to the construction of a needed Contingent Facility are only evaluated against the violations in which system reinforcement mediates.

The interim deliverability study results are only valid for the RPM auction Delivery Year for which they were studied. The Delivery Year is defined as June 1st of the first year to May 31st of the following year (e.g., the Delivery Year for the 2024/25 3rd Incremental Auction is considered to be from June 1st 2024 to May 31st 2025). The base case used for the interim study will be based off of an RTEP case of the Delivery Year under study. The Provisional Interconnection Service granted through the interim deliverability study process will be publicly posted.

The flowgate loading for the interim deliverability study performed follows the Generator Deliverability Procedure detailed in C.3 of Manual 14B.

A project is considered fully deliverable if the project only contributes to flowgates with a post study loading less than 100% or has a MW contribution less than 1% of the line rating to an overloaded flowgate. A project is considered not deliverable if the MW contribution is 1% or greater of the line rating of a previously overloaded flowgate.

For flowgates that are not overloaded prior to the interim deliverability study but are overloaded at the end of the interim deliverability study, deliverable MW's will be determined via a cluster study methodology and will be allocated proportionally based on the project's MW impact to the flowgate and distribution factor (DFAX).

At PJM's discretion, PJM may allow Provisional Interconnection Service for projects with Contingent Facilities to operate as energy-only resources for a particular Delivery Year. During such periods, PJM reserves the right to deny Provisional Interconnection Service for projects or to limit total injections for projects consistent with the results of the interim deliverability study (which may be less than the Maximum Facility Output).

The interim deliverability study shall include any additional studies necessary to evaluate a New Service Request's eligibility for Provisional Interconnection Service.

Note:

- Even if a project is found to be deliverable or granted Provisional Interconnection Service for a particular Delivery Year, interim deliverability must be requested for each additional Delivery Year that the conditions apply. An energy-only resource is eligible for Provisional Interconnection Service but not awarded Capacity Interconnection Rights.
- Projects operating under Provisional Interconnection Service will be dispatched consistent with all applicable operating procedures including, but not limited to, those established in M-12 and M-14D.

4.10.1.4 Eligibility Requirements for Interim Deliverability Studies

Requests for interim deliverability studies for a particular Delivery Year shall be made a minimum of eleven months prior to the start of that Delivery Year. Only projects with an executed GIA or ISA or have confirmation from their PJM Project Manager that they are expected to receive a GIA prior to the 3rd Incremental Auction may participate in the interim deliverability study for that Delivery Year. Requests received after the start of the interim deliverability study will not be considered. Refer to PJM Capacity Market Manual 18, Section 4.2.4, for eligibility requirements to participating in a PJM RPM auction.

4.10.2 Winter CIR Study

4.10.2.1 Applicability

In alignment with the RPM auction schedule and according to PJM Tariff Part VIII, Section 430, PJM solicits requests from Owners of Intermittent Resources and Environmentally Limited Resources which seek to obtain additional Capacity Interconnection Rights (CIRs) for the winter period of each Base Residual Auction (BRA) year. If granted, the additional rights are for a period of one year as specified by PJM in the solicitation. Refer to PJM Capacity Market Manual 18, Section 4.10 for Seasonal Capacity Performance Resources.

Requests for additional CIRs are received during a ten day request submittal window announced by PJM prior to the opening of the BRA auction. The requests are studied on the case year of the applicable BRA year in which the request was made. The requests are studied to prevent infringement on the available system resources, including any units already in service, units with a GIA or Upgrade Construction Service Agreement, or any New Services Project that has rights to the case year under study.

4.10.2.2 Analysis for Winter CIR Study

The Winter CIR study performed follows the Generator Deliverability Procedure detailed in C.3 of Manual 14B. As the submitted requests are for additional capacity, only single contingencies are reviewed for deliverability. Requested additional CIRs are considered not deliverable if the MW contribution is 1% or greater of the line rating of a previously overloaded flowgate. For flowgates that are not overloaded prior to the Winter CIR study but are overloaded at the end of the Winter CIR study, deliverable MW's will be determined via a cluster study methodology. Deliverable MW's will be allocated proportionally based on the project's MW impact to the flowgate and distribution factor (DFAX).

Note:

A cluster study methodology will be used starting with the RPM auction aligned to RTEP year used for Transition Cycle #1. For all prior delivery years, a serial study process will be used.

Even if the project is found to be deliverable for a particular BRA year, the Winter CIR Study must be performed for each applicable BRA year desired by the Generator Owner.

4.10.2.3 Timeline for Winter CIR Study Process

Below is a typical schedule for the Winter CIR study process.

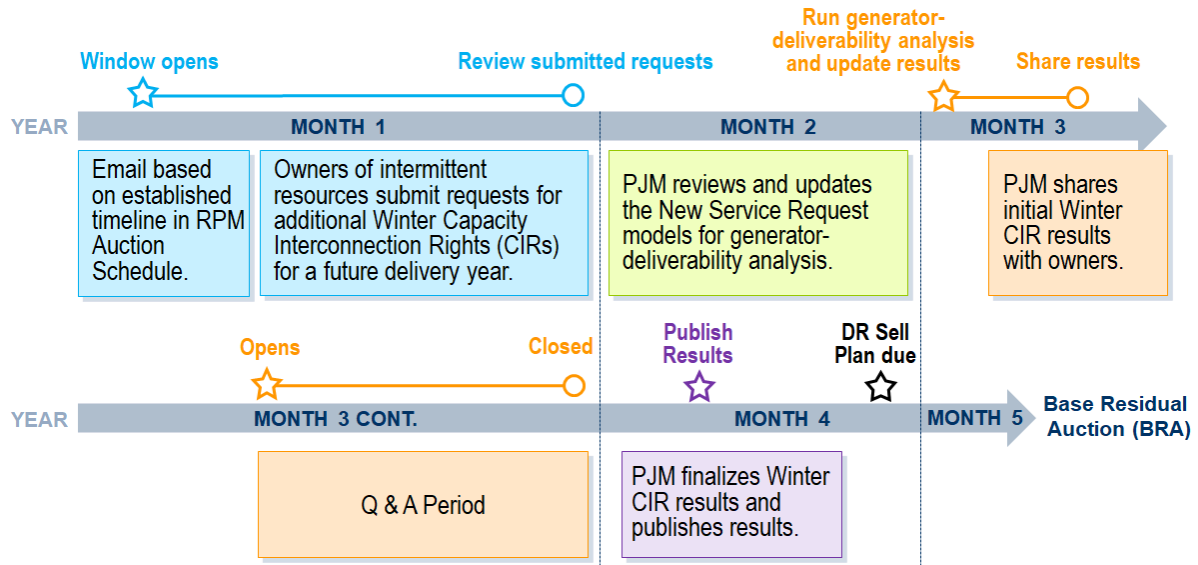

Exhibit 14: Timeline for Winter CIR Study

Section 5: Final Agreement Negotiation Phase

Section 5 describes the Final Agreement Negotiation Phase. The Final Agreement Negotiation Phase starts on the first Business Day immediately following the end of Phase III, and runs concurrently with Decision Point III.

The purpose of the Final Agreement Negotiation Phase is to:

1. Negotiate, execute and enter into the applicable final interconnection related service agreement found in Tariff, Part IX;
2. Conduct any remaining analyses or updated analyses based on New Service Requests withdrawn during Decision Point III; and
3. Adjust the security obligation based on New Service Requests withdrawn during Decision Point III and/or during the Final Agreement Negotiation Phase.

The “Final Agreement Negotiation Phase” procedures are outlined in Tariff, Part VII, Subpart D, section 314 and Tariff, Part VIII, Subpart D, section 411.

PJM shall use Reasonable Efforts to complete the Final Agreement Negotiation Phase within 60 days of the start of the Phase. If the 60th day does not fall on a Business Day, the phase shall be extended to end on the next Business Day.

The terms and procedures for the Final Agreement Negotiation Phase are summarized below.

5.1 Draft Agreement:

Prior to the start of the Final Agreement and Negotiation Phase, PJM will provide an electronic draft interconnection related agreement from Tariff, Part IX (as applicable to the Project Developer’s or Eligible Customer’s New Service Request) to the parties to the interconnection related agreement.

The initial draft interconnection related agreement is prepared using the study results available from Phase III or the most-recently completed studies conducted during the Final Agreement Negotiation Stage. However, if a different New Service Request is withdrawn during Decision Point III, after a draft agreement has been tendered to Project Developer or Eligible Customer, and that withdrawn New Service Request impacts the Project Developer’s or Eligible Customer tendered draft, PJM shall use Reasonable Efforts to update and reissue the tendered draft within 15 Business Days.

If a New Service Request is withdrawn during the Final Agreement Negotiation Phase, PJM removes the New Service Request from the Cycle and adjusts the Security obligation of other New Service Requests based on the withdrawal.

5.2 Negotiation:

Upon receipt of the draft agreements, Project Developer or Eligible Customer, and Transmission Owner, as applicable, will have 20 Business Days to return written comments on the draft agreements.

PJM will have then 10 Business Days to respond and provide revised drafts of the agreements in electronic form, if appropriate.

Parties may use not more than 60 days following the start of the Final Agreement Negotiation Phase to negotiate the terms of the draft agreements. However, PJM, in its sole discretion, may extend the Final Agreement Negotiation Phase beyond 60 days.

5.3 Impasse

PJM, the Project Developer or Eligible Customer or Transmission Owner may determine that the negotiation is at an impasse.

1. The party determining that final agreement negotiations are at an impasse shall provide written notification to the other parties of the impasse, and may:
 - a. request PJM to file the unexecuted agreement with FERC, or
 - b. request in writing dispute resolution as allowed under Tariff, Part I, Section 12, or if concerning the Regional Transmission Expansion Plan consistent with Operating Agreement, Schedule 5.

If PJM, in its sole discretion, determines that the negotiations are at an impasse, PJM will provide written notification to the other parties, and may file the unexecuted agreement with the FERC.

5.4 Project Developer or Eligible Customer Execution:

No later than five Business Days following the end of negotiations within the Final Agreement Negotiation Phase, PJM will tender the final interconnection related agreement to the parties in electronic form.

No later than fifteen Business Days after receipt of the final interconnection related agreement, Project Developer or Eligible Customer shall either:

1. Execute the final interconnection related service agreement in electronic form and return it to PJM electronically;
2. Request in writing dispute resolution as allowed under Tariff, Part I, section 12 or, if concerning the Regional Transmission Expansion Plan, consistent with Operating Agreement, Schedule 5; or

3. Request in writing that PJM file with FERC the final interconnection related service agreement in unexecuted form, with the unexecuted interconnection related service agreement containing terms and conditions deemed appropriate by PJM for the New Service Request; and
4. Provide any required adjustments to Security.

5.5 Transmission Owner Execution:

If Project Developer or Eligible Customer executes the final interconnection related service agreement, then, no later than 15 Business Days after PJM sends notification to the relevant Transmission Owner(s), the relevant Transmission Owner(s) shall either:

1. Execute the final interconnection related agreement in electronic form and return it to PJM electronically;
2. Request in writing dispute as allowed under Tariff, Part I, section 12 or, if concerning the Regional Transmission Expansion Plan, consistent with Operating Agreement, Schedule 5; or
3. Request in writing that the PJM file with FERC the final interconnection related agreement in unexecuted form, with the unexecuted interconnection related agreement containing terms and conditions deemed appropriate by PJM for the New Service Request.

5.6 PJM Execution:

After the Project Developer or Eligible Customer and relevant Transmission Owner(s) have executed the interconnection related agreement, then PJM shall either:

1. Execute the agreement;
2. Request in writing dispute resolution as allowed under Tariff, Part I, section 12 or, if concerning the Regional Transmission Expansion Plan, consistent with Operating Agreement, Schedule 5; or
3. File with FERC the agreement in unexecuted form.

5.7 Proceeding under Interconnection Related Agreement:

Parties may not proceed under the interconnection related service agreement until:

1. 30 days after the agreement, if executed and nonconforming, has been filed with FERC;
2. The agreement, if unexecuted, has been filed with and accepted by FERC; or
3. The earlier of 30 days after the agreement, if conforming, has been executed or has been reported in PJM's Electronic Quarterly Reports.

Section 6: Study and Readiness Deposits

Section 6 describes Study Deposit and Readiness Deposit requirements for New Service Requests.

6.1 Study Deposits

A Study Deposit is a one-time deposit due at the beginning of the study process. The Study Deposit is non-binding, and actual study costs may exceed the Study deposit.

A Project Developer or Eligible Customer (collectively, applicant) submitting a New Service Request must provide a Study Deposit prior to the Application Deadline. The Study Deposit will range from \$75,000 to \$400,000 depending on the MW size of the project, as shown in the table below. The applicant will be responsible for paying actual study costs.

Project Size	Study Deposit
0-20 MW	\$75,000
>20-50 MW	\$200,000
>50-100 MW	\$250,000
>100-250 MW	\$300,000
>250-750 MW	\$350,000
>750 MW	\$400,000

Exhibit 15: Study Deposit Requirement

Note:

The applicant must send Study Deposit by wire transfer. The wire transfer must specify the corresponding reference number or PJM will not review or process the application. The applicant must also enter the wire number in the PJM data submission form for each application. A separate Study Deposit wire is required for each individual application.

The MW project size used to determine the Study Deposit is summarized below:

Type of Request	MW for Deposit Calculation
Generation Interconnection Request	the higher of the requested Maximum Facility Output or Capacity Interconnection Rights

Transmission Interconnection Request	the higher of the requested firm (capacity) TIR/TWR or non-firm (energy) TIR/TWR
Long Term Firm Transmission Service	the transmission capacity requested

Exhibit 16: MW for Study Deposit Calculation

Note:

For requests to add another resource type to an existing or planned facility, the required Study Deposit and Readiness Deposit will be based on the equipment technology size (MW) installed, even if no increase of MFO or capacity is requested.

6.1.1 Additional Study Costs

Actual study costs may exceed the Study Deposit amount collected. In these cases, PJM will notify the applicant of the shortfall amount. The applicant will have 20 Business Days to provide the additional funds or withdraw. If applicant fails to satisfy either of these requirements, PJM shall terminate and withdraw the New Service Request.

6.1.2 Study Deposit Refunds

The table below summarizes the timing of the Study Deposit refunds.

Category	Percentage	Timing of Refund
Refundable	90%	Refunded at the conclusion of required studies
Non-refundable	10%	Non-refundable prior to commercial operation. Refunded upon reaching commercial operation

Exhibit 17: Study Deposit Refund

6.1.2.1 Non-refundable Portion of Study Deposit

Ten (10%) of the Study Deposit is non-refundable and can be used by PJM to fund any restudies that are required if the applicant withdraws the request. If applicant withdraws its New Service Request, or the New Service Request is deemed rejected or terminated and withdrawn, any unused portion of the refundable deposit will be used to fund:

1. Any outstanding monies owed by applicant in connection with outstanding invoices due to PJM, Transmission Owner(s), and/or third party contractors, as applicable, as a result of any failure of applicant to pay actual costs associated with the New Service Request;

2. Any restudies as a result of the rejection, termination, and/or withdrawal of the New Service Request; and/or
3. Any outstanding monies owed by applicant in connection with outstanding invoices related to other New Service Requests

6.1.2.2 Refundable Portion of Study Deposit

The remaining 90% of the Study Deposit is refundable at the conclusion of the required studies for the New Service Request, after all outstanding invoices related to the present or prior New Service Request have been paid by the applicant as described below.

PJM shall utilize, in no particular order, the refundable portion of each total deposit amount to cover the following:

1. The cost of the application review;
2. The dollar amount of applicant's cost responsibility for the System Impact Study; and
3. If the New Service Request is modified, rejected, terminated, and/or withdrawn, refundable deposit money shall be applied to cover all of the costs incurred by PJM up to the point of the New Service Request being modified, rejected, terminated and/or withdrawn, and any remaining refundable deposit monies shall be applied to cover:
 - a. The costs of any restudies required as a result of the modification, rejection, termination, and/or withdrawal of the New Service Request;
 - b. Any outstanding monies owed by applicant in connection with outstanding invoices due to PJM, Transmission Owner(s), and/or third party contractors, as applicable, as a result of any failure of applicant to pay actual costs associated with the New Service Request; and/or
 - c. Any outstanding monies owed by Applicant in connection with outstanding invoices related to other New Service Requests.

If any refundable deposit monies remain after all costs and outstanding monies owed, as described in this section, are covered, such remaining refundable deposit monies shall be returned to applicant.

6.2 Readiness Deposits

Readiness Deposits are funds committed by the Project Developer or Eligible Customer based upon MW project size and, where applicable contribution to Network Upgrades as defined below. They are not used to fund studies nor to offset Security.

There are a maximum of three Readiness Deposits due, and they are determined at the time they are due.

The Readiness Deposit No. 1 is due upon application submission. Readiness Deposits No. 2 is due at Decision Point I, and Readiness Deposit No. 3 is due at Decision Point II.

Readiness Deposit No. 2 and Readiness Deposit No. 3 will be calculated based on a project's contribution to Network Upgrades determined in Phase I or Phase II, respectively. Readiness Deposits must be provided through a wire transfer or a letter of credit.

Note:

The applicant's wire transfer or letter of credit must specify the corresponding reference number or PJM will not review or process the application.

A separate Readiness Deposit wire or letter of credit is required for each individual application.

Readiness Deposit requirements are summarized in the table below:

	Applicable Phase	Readiness Deposit Required	Readiness Deposit Due
Readiness Deposit No. 1 (RD1)	Application Submission	\$4,000 x Project Size (MW) See Note 1	RD1 = \$4,000 x Project Size (MW) See Note 1
Readiness Deposit No. 2 (RD2)	Decision Point I	The greater of: (10% of cost allocation for required Network Upgrades as determined in Phase I or RD1) minus RD1	RD2 = 10% of cost allocation for required Network Upgrades <i>minus</i> RD1 See Note 2
Readiness Deposit No. 3 (RD3)	Decision Point II	The greater of: (20% of cost allocation for required Network Upgrades as determined in Phase II or (RD1 + RD2)) minus (RD1 + RD2)	20% of cost allocation towards required Network Upgrades <i>minus</i> (RD1 + RD2)

Exhibit 18: Readiness Deposit Requirements

Note 1: Project size refers to the higher of the requested Maximum Facility Output or Capacity Interconnection Rights.

Note 2: Readiness Deposit No.2 and Readiness Deposit No.3 can be zero, but may not be a negative number.

6.2.1 Readiness Deposit Refunds

Readiness Deposits are not to be refunded or reduced based upon later project reductions or cost allocation changes. Refunds of Readiness Deposit Nos. will be issued when all Cycle New Service Requests have either: 1) entered into final agreements and met the Decision Point III Site Control requirements or 2) withdrawn.

Readiness Deposits are partially or wholly at risk if a project is withdrawn or deemed terminated. Upon withdrawal or termination of a New Service Request, PJM will refund the portion of the paid Readiness Deposits that are not at risk.

Readiness Deposit	Amount At Risk (Transition Cycle No. 1 Only)	Amount At Risk (All Other Cycles)
Readiness Deposit No. 1	Prior to the start of Phase I – not at risk Phase I to the close of Decision Point 1 – not at risk After Decision Point 1 – 100% at risk	Prior to the start of Phase I – not at risk Phase I to the close of Decision Point 1 – 50% at risk After Decision Point 1 – 100% at risk
Readiness Deposit No. 2	Prior to the close of Decision Point 2 – not at risk After Decision Point 2 – 100% at risk	Prior to the close of Decision Point 2 – not at risk After Decision Point 2 – 100% at risk
Readiness Deposit No. 3	100% at risk	100% at risk

Exhibit 19: Readiness Deposit at Risk

If a Project Developer or Eligible Customer chooses to withdraw their New Service Request at Decision Point I, and is eligible to receive a partial refund of 50% of Readiness Deposit that was provided in the form of a letter of credit, the Project Developer or Eligible Customer will be required to revise the amount of the letter of credit to reflect the remaining 50% that will be held or converted to cash.

6.2.2 Treatment of Readiness Deposits due to Adverse Study Results

Adverse study results tests will be applied at Decision Point II and III. If a New Service Request meets the criteria below and chooses to withdraw the request, PJM will refund the cumulative Readiness Deposit amounts paid by the Project Developer or Eligible Customer at the Application Phase and at Decision Point I.

Adverse Study Results Test Criteria:

- At Decision Point II, there is an increase in Network Upgrade costs allocated to the project of 25% or more **and** an increase of more than \$10,000 per MW from Phase I study results.
- At Decision Point III, there is an increase in Network Upgrade costs allocated to the project of 35% or more **and** an increase of more than \$25,000 per MW from Phase II study results.

6.2.3 Forfeited Readiness Deposits

Readiness Deposits from withdrawn projects, that have not triggered the adverse study results test, may be forfeited. **Forfeited Readiness Deposits** are pooled throughout the Cycle to be used to mitigate late-stage withdrawals.

Late-stage withdrawals those that occur after Phase III studies are complete. Withdrawals at the end of the study process provide a small window for those projects remaining to adjust, and significant costs shifts may make remaining projects less viable.

Once all projects in the Cycle have made their decisions, PJM will perform a retool study, incorporating projects that were withdrawn prior to executing their final agreement, to determine what system Network Upgrades remain necessary. **Underfunded Network Upgrades** will be identified, and forfeited Readiness Deposits will be used to help fund these upgrades. It is possible that there will not be enough funds in the forfeited Readiness Deposit pool to mitigate all underfunding or there could be a surplus. If there are not enough funds to mitigate all underfunded Network Upgrades, the cost allocation of the remaining New Service Requests in the Cycle will increase accordingly. Any remaining Readiness Deposits will be refunded to Project Developers and Eligible Customers on a pro-rata basis. If after the retool no underfunded Network Upgrades are identified, all Readiness Deposits will be refunded.

At the point PJM disposes the Forfeited Readiness Deposits, a Project Developer or Eligible Customer that wishes to proceed to Final Agreement Negotiation Phase III must provide Security based on the Network Upgrades costs allocated to it pursuant to the Phase III System Impact Study results. Project Developers and Eligible Customer will have before the close of Decision Point III or is New Service Request will be deemed terminated and withdrawn.

6.3 Deposit Timeline

The diagram below summarizes when each deposit is due and the percentage of each deposit at risk during each phase. The final Site Control demonstration referenced in the chart can occur at Decision Point III or within 180 days from the effective date of the final agreement.

Note:

Notwithstanding the diagram below, for Project Developers and Eligible Customers in Transition Cycle No. 1 only:

1. Readiness Deposit No. 1 is not at risk prior to the close of Decision Point I.
2. Readiness Deposit No. 1 is 100% at risk after the close of Decision Point I.

	Application Submission	Application Review	Phase 1	Decision Point 1	Phase 2	Decision Point 2	Phase 3	Decision Point 3	Final Agreement	Final Site Control Demonstration
Study Deposit										
Readiness Deposit 1										
2										
3										

= deposit due
 = deposit not at risk
 = 10% of deposit is at risk
 = 50% of deposit is at risk
 = 100% of deposit is at risk

Exhibit 20: Deposit Timeline

6.4 Separate Treatment for Deposits and Security

Study Deposits and Readiness Deposits are held separately, are non-transferrable, and cannot be commingled. If a Project Developer or Eligible Customer is sending Readiness Deposit No. 1 by wire transfer, it must send a separate wire transfer for its Study Deposit.

Readiness Deposits are also held separately from Security funds. Security is collected during the Final Agreement Negotiation Phase. By contrast, Readiness Deposits may be available for refund once all Decision Point III Site Control requirements have been met and the final agreement is executed.

Summary of acceptable forms of payment:

Type of Payment	Acceptable Forms
Study Deposit	Wire transfer
Readiness Deposit	Wire transfer or letter of credit

Final Agreement Security	Wire transfer or letter of credit or other form of Security deemed acceptable by PJM.
--------------------------	---

Exhibit 21: Acceptable Forms of Deposits and Security

Note:

Consistent with the Tariff, PJM has the discretion of determining what forms of Security it may accept. PJM reserves the right to only accept Security in the form of a letter of credit in certain circumstances.

Letters of credit are subject to review and approval by PJM. PJM requires a minimum of 10 Business Days to evaluate and provide comments on draft letters of credit.

PJM maintains various letters of credit templates. Project Developers/Eligible Customers must use the templates that are specifically designated for use for Readiness Deposit or Security, as applicable.

PJM will consider the following proposed revisions to the letter of credit template:

- Proposed revisions to provisions regarding the presentation of any payment demand to reflect Issuer's communication procedures, provided that such revisions may not add conditions to the effectiveness of any presentation of payment demand.
- New York choice of law, instead of Pennsylvania, where Issuer is a bank based in New York.
- Alternative language if Issuer has standard language on the provision regarding payment under the letter of credit to any person who is listed on a United Nations, European Union or United States of America sanctions list, or to any person with whom the issuing bank is prohibited from engaging in transactions under applicable United States federal or state anti-boycott, anti-terrorism, anti-money laundering, or trade or economic sanctions laws.

All other proposed revisions will not be accepted.

Section 7: Site Control

The Tariff states that a Project Developer must show evidence of Site Control; and Site Control is required for a project to have and maintain a valid New Service Request position throughout the various phases of a Cycle.

Site Control is evidence demonstrating a Project Developer's interest in, control over and right to utilize a Site for purposes of constructing a Generating Facility, Merchant Transmission Facilities, Interconnection Facilities and, if applicable, Transmission Owner's Interconnection Facilities and/or Network Upgrades at the Point of Interconnection. Site Control helps demonstrate readiness.

The Tariff provides PJM the authority to verify that a demonstration of Site Control is fully sufficient for the technology and MWs requested for a proposed Generating Facility. PJM ensures that Generation Project Developers proposing facilities have adequate land to support the proposed generation facilities required to preserve the PJM system rights (MW Energy and MW Capacity) they seek to obtain through their New Service Request. A New Service Request for more MW capability than the Site and/or proposed technology could potentially harm other Project Developers or Eligible Customers by reducing available system capability.

7.1 Site Control Requirements

Site Control submitted must meet the evidentiary requirements as stated in Tariff Part VII, Subpart A, Section 302, and Tariff Part VIII, Subpart A, Section 402.

7.1.1 Site Control Entity

Site Control must be in the name of the Project Developer identified on the New Service Request. Otherwise, the Project Developer must demonstrate to PJM's satisfaction the relationship between the entity owning or controlling the site (i.e., the landowner) and the Project Developer that submitted the New Service Request.

7.1.2 Requirements for Multiple New Service Requests Sharing Site

If multiple New Service Requests plan to utilize the same Site, the Project Developer must provide evidence that the total acreage amount of the Site is adequate to support all such related New Service Requests. In such instances, the Project Developer must include with its New Service Request evidence demonstrating that the project referenced in the Project Developer's New Service Request is "concurrently feasible" with the development of any other projects that will share the Site identified in the Site Control. Proof of concurrent feasibility shall include:

- Identification of any other New Service Requests that will share all or a portion of the Site identified in the Site Control; and

- Identification of the proposed location and space utilization of all projects that will share the Site, including acreage and boundaries for all projects sharing the Site identified in the Site Control; and
- Any related technical information required by PJM to determine that development of the project referenced in the submitted New Service Request is not inconsistent with development of any of the other New Service Requests that will share all or a portion of the same Site.

Note:

To the extent that multiple New Service Requests are submitted using the same Site Control evidence and the total acreage amount of such Site is not adequate to support all such New Service Requests, **all such New Service Requests shall be deemed terminated and withdrawn.**

- Project Developers are prohibited from submitting evidence of Site Control for the same Site which is also the subject of an interconnection request with an adjacent Regional Transmission Organization (RTO), Independent System Operator (ISO), or other system in connection with a New Service Request submitted to PJM. To the extent that the Project Developer submits evidence of Site Control for the Site which is also the subject of an interconnection request with an adjacent RTO, ISO, or other system, the PJM New Service Request shall be deemed terminated and withdrawn.
- Multiple projects may share Project Developer Interconnection Facilities. A shared facilities agreement is required if jointly owned common Interconnection Facilities are proposed.

7.1.3 Acceptable Forms of Site Control

Evidence of Site Control can be submitted in the form of one of the following:

- A deed; or
- A lease; or
- An option to lease or purchase; or
- As deemed acceptable by PJM, any other contractual or legal right to possess, occupy and control a Site.
- Rights of Way are only acceptable for Project Developer Interconnection Facilities up to the Point of Interconnection.
- For New Service Requests with Sites owned or controlled by a state or federal governmental entity, and authorization for such use is subject to environmental and other state and/or federal government permitting requirements, evidence of Site Control can be in any form the governmental entity issues. At Decision Points I and III, the Project Developer must provide evidence acceptable to PJM that it is taking identifiable steps to further the issuance of authorization by the governmental entity. This evidence must

include documentation describing the source of and effects of the regulatory permitting requirements.

7.1.4 Unacceptable Forms of Site Control

The following are not acceptable forms of Site Control

- Memorandums are not acceptable.
- Documents solely evidencing of intent to purchase or control the Site will not be accepted.

7.1.5 Key Elements of Site Control Evidence

Site Control evidence must demonstrate three key elements: conveyance, term, and exclusivity.

1. Conveyance is demonstrated through evidence submitted by the Project Developer that conveys the Site to the Project Developer (e.g., a deed or lease) or guarantees the Project Developer the right to future conveyance at Project Developer's sole discretion (e.g., an option to lease or option to purchase). A Memorandum of Understanding (MOU) or a Letter of Intent (LOI) is not sufficient to demonstrate conveyance.
2. Term is the minimum duration required to evidence Site Control, and the requirements for term are established at various points within a Cycle. The term requirement cannot be satisfied by an agreement with extensions with an initial term shorter than the required term for a particular point within a Cycle, unless those extensions have been exercised and any requisite conditions fulfilled, including payment obligations. See the "Site Control Term Requirements" table in this section for requirements.
3. Exclusivity is evidenced by written acknowledgement from the land owner of the identified Site that, for the term the Project Developer has exclusive use of the Site for the purpose identified in the relevant New Service Request. The land owner cannot make the identified Site property available for purchase or lease to anyone other than the Project Developer for any purpose or use that will interfere with the rights granted to the Project Developer.

7.1.6 Acreage Requirements

Evidence of Site Control must demonstrate to PJM's satisfaction that the total feet or acreage of the Site is adequate for the resource-specific technology and MW's requested. Acreage requirements for the Generating Facility are summarized in the table below.

Note:

For requests to add another resource type to an existing or planned facility, the required Site Control acreage will be based on the equipment technology size installed even if no increase of MFO or capacity is requested.

In the event of a disagreement between PJM and the Project Developer over whether the total acreage of the Site is fully sufficient for the resource-specific technology and MWs requested for a proposed Generating Facility or Merchant Transmission Facility, PJM will accept a

Professional Engineer (PE, licensed in the state in which the project is located) stamped Site plan drawing that depicts the proposed generating facility arrangement and specifies the MFO for that arrangement.

Technology	Acreage Requirement
Solar	5 acres/MW
Wind	30 acres/MW
Battery Storage	1 acre/100 MWH
Synchronous Generator	10 acres per facility

Exhibit 22: Generating Facility Acreage Requirements by Project Technology

7.1.7 Site Control Evidence Summary

In the event that a Project Developer submits Site Control evidence for more than one parcel of land, a spreadsheet summarizing evidence is required.

The spreadsheet must include name of each files provided, parcel identification number of each parcel under control and acreage of parcel and total acreage for the submission.

7.1.8 Site Plan Requirements

Project Developers must submit a Geographic Information System (GIS) Site Plan map and data files acceptable to PJM showing the arrangement of the resource-specific proposed facilities for the amount of MWs requested in either of the following file formats:

1. ESRI Shapefile (.SHP). This is the PJM preferred format.
2. Google Earth KML (.KML or .KMZ)

This Site plan must contain the Site boundaries, layout of Generating Facilities or Merchant Transmission Facilities, location of collector bus, location of interconnection switchyard (if applicable), and the proposed Point of Interconnection. Examples of Site plans can be found in Attachment J. Any project that does not provide a GIS Site plan will be found deficient.

At Decision Point I and Decision Point III, Project Developer must provide plans for right-of-way from generating Site to the proposed Point of Interconnection. Additional details are described in the “Site Control Requirements in the Cycle Process” section below.

7.1.9 Site Control Certification and Land Owner Attestation

In addition to the Site Control documentation, at each point within a Cycle at which Site Control must be demonstrated PJM will also require a Site Control certification signed by an officer or person that has authority to make decisions on behalf of the Project Developer. Site Control certifications do not replace Site Control.

At PJM's request, Project Developers must also provide landowner attestations, county recordings, or other such similar documentation to validate Site Control certifications. This documentation can be used at PJM's discretion for verification of conveyance, exclusivity, and term in addition to the Site Control documentation. The latest Site Control certification and landowner attestation templates will be posted on the PJM website.

7.2 Site Control Requirements in the Cycle Process

The following describes the Site Control required at each phase of a Cycle.

7.2.1 Application Phase

Application Phase requirements are summarized below:

- Full (100%) Site Control must be provided for the Generating Facility during the Application Phase. If deficiencies are found and not resolved, the application will be terminated and the project withdrawn.
- The term required in the Application Phase is one year from the Application Deadline.
- Officer Certifications are required to verify Site Control in addition to the Site Control documentation.
- Landowner attestation or county recording may be required at PJM's discretion.
- A Site plan is required as outlined above.
- Merchant Transmission projects must provide evidence of 100% Site Control for the land needed for transmission substation facilities (e.g. HVDC converter station, phase angle regulator (PAR), and/or a variable frequency transformer (VFT)) for a term of one year from the Application Deadline.

The Generating Facility Site Control submitted during the Application Phase establishes the initial Site that will be used to compare to Site Control submissions at Decision Point I. Any Site additions at Decision Point I need to be adjacent parcels or have evidence of easements to this initial Site.

7.2.2 Decision Point I

Decision Point I requirements are summarized below:

- The Project Developer must once again provide evidence of 100% Site Control for the Generating Facility for an additional one year term beginning from the last day of Phase I.
- The Project Developer can add and remove parcels of the Generating Facility Site provided the following requirements are met:
 - The provided Generating Facility Site continues to cover 100% of the required acreage per requirements in Manual 14H Section 7.1.6

- Any additions to the Site are either adjacent or evidence of easement between the initial Site provided at application and the Site added at DP1 is provided.
 - Any additions to the Site need to meet requirements in Manual 14H Section 7.1, including term, exclusivity, and conveyance.
- Demonstration of Site Control of parcels that have been removed is NOT required
- The Generating Facility provided at DP1, with any allowed modifications, will be the "initial Site" that the DP3 submission will be evaluated against.

Note:

If submitting updated Site Control and the new parcels provided are not contiguous with those of the Site Control previously supplied, then evidence of easements between the new and previously submitted parcels will be required.

SUBMISSION Application

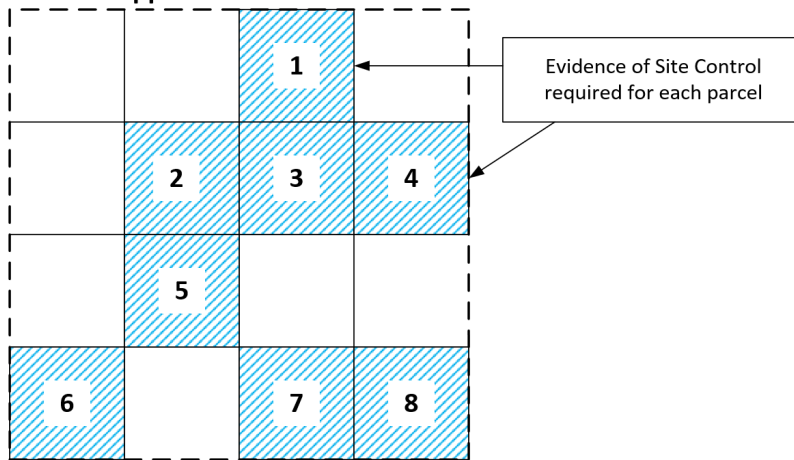

SUBMISSION DP1

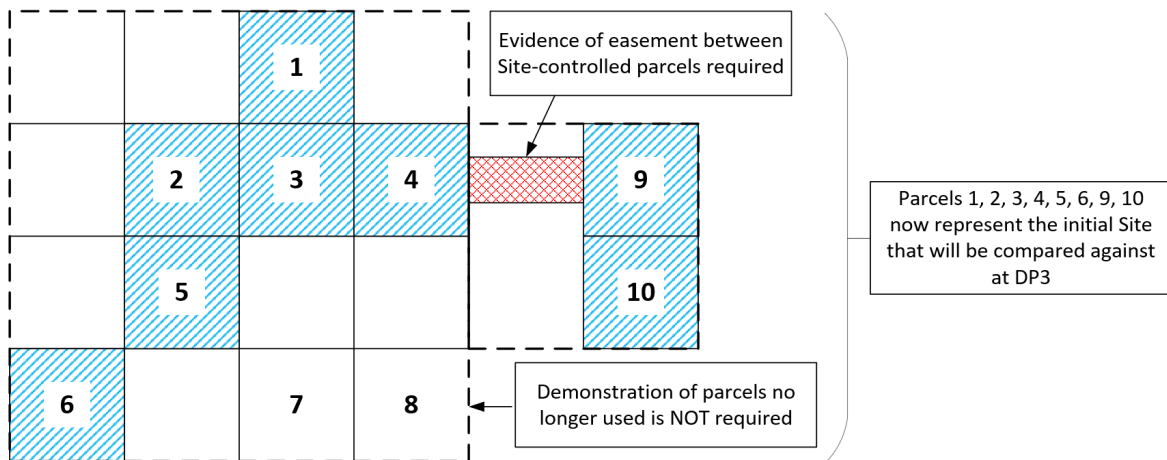

Project drops parcels 7 and 8 and adds parcels 9 and 10 with evidence of easement.

Exhibit 23: Site Control Change Example: Allowable Changes Between Application and DP1

- The Project Developer must also provide evidence of 50% Site Control for Project Developer Interconnection Facilities to the Point of Interconnection. Evidence of Site Control for Project Developer Interconnection Facilities may include, in addition to a deed, lease, or option, right-of-way.
- The Project Developer must provide evidence of 50% Site Control for the new interconnection switchyard, if applicable.
- Officer Certifications will be required to verify Site Control in addition to the Site Control documentation.
- Landowner attestation or county recording may be required at PJM's discretion

- A Site plan is required as outlined above.
- For projects that are eligible to accelerate to final agreement at Decision Point I, all Decision Point III Site Control requirements must be met at Decision Point I.

7.2.3 Decision Point II

- There are no Site Control requirements associated with Decision Point II and demonstration of Site Control is not required.
- Any changes made to Site Control during Decision Point II will be subject to and evaluated consistent with the modification requirements at Decision Point III.
- For projects that are eligible to accelerate to final agreement at Decision Point II, all Decision Point III Site Control requirements must be met at Decision Point II. Refer to Manual 14H Section 4.6.3 for more information.

7.2.4 Decision Point III

Decision Point III requirements are summarized below:

- For New Service Requests in Transition Cycle #1 and Transition Cycle #2:
 - The Project Developer must show full (100%) Site Control for the Generating Facility, Interconnection Facilities, and the interconnection switchyard for an additional one year from the last day of Phase III.
- For New Service Requests in the new Cycle process:
 - The Project Developer must show full (100%) Site Control for the Generating Facility, Interconnection Facilities, and the interconnection switchyard for an additional three years from the last day of Phase III.
- The Project Developer can add and remove parcels provided the following requirements are met:
 - The provided Generating Facility Site continues to cover 100% of the required acreage per requirements in Manual 14H Section 7.1.6
 - Any additions to the Site are either adjacent or evidence of easement between the initial Site provided at DP1 and the Site added at DP3 is provided.
 - Any additions to the Site need to meet requirements in Manual 14H Section 7.1, including term, exclusivity, and conveyance.
 - Demonstration of Site Control of parcels that have been removed is NOT required
 - Any proposed modifications to previously submitted parcels for the Interconnection Facilities or Interconnection Switchyard do not affect the issued System Impact Studies (I, II, III) or the completed facilities studies.

SUBMISSION DP1

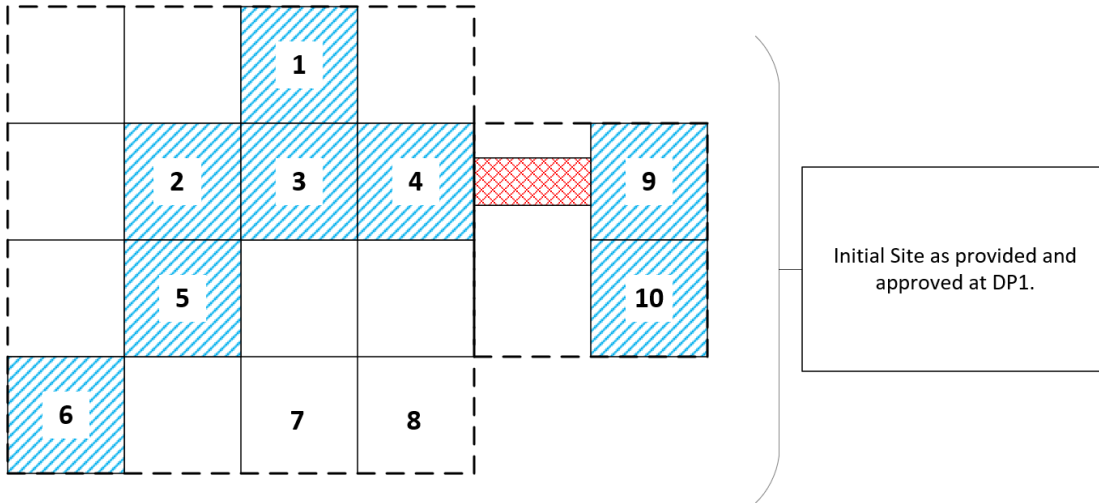

SUBMISSION DP3

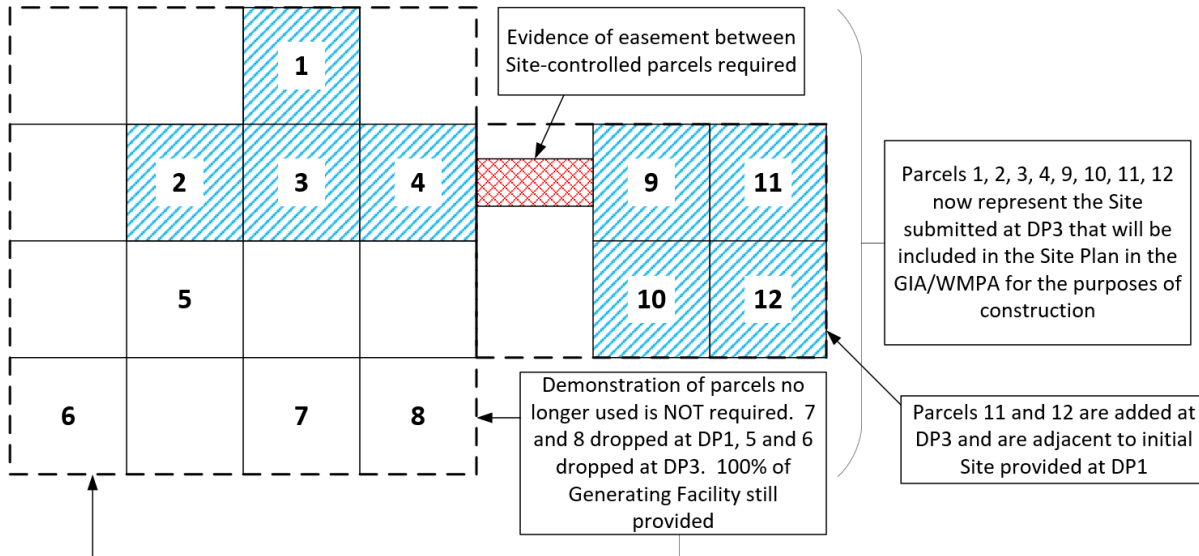

Continued progression of project in Exhibit 23 - project drops parcels 5 and 6 and adds parcels 11 and 12

Exhibit 24: Site Control Change Example Continued: Allowable Changes Between DP1 and DP3









- Officer Certifications will be required to verify Site Control in addition to the Site Control documentation.

- Landowner attestation or county recording may be required at PJM's discretion.
- A Site plan is required as outlined above.
- For New Service Requests in Transition Cycle #1 and Transition Cycle #2:
 - For Merchant Transmission projects, full (100%) Site Control for a period of at least one year from the last day of Phase III is required for transmission line and substation facilities. If 100% Site Control for transmission line facilities for a period of at least one year from the last day of Phase III is not obtained by Decision Point III, the Project Developer will need to acquire that level of Site Control within 180 days of the effective date of the GIA.
- For New Service Requests in the new Cycle process:
 - For Merchant Transmission projects, full (100%) Site Control for a period of at least three years from the last day of Phase III is required for transmission line and substation facilities. If 100% Site Control for transmission line facilities for a period of at least three years from the last day of Phase III is not obtained by Decision Point III, the Project Developer will need to acquire that level of Site Control within 180 days of the effective date of the GIA.

Note:

If 100% Site Control is not obtained by Decision Point III, then Project Developer must show concrete evidence acceptable to PJM that it is in negotiations to obtain 100% Site Control for a period of at least one or three years, as applicable, from the last day of Phase III. If such acceptable evidence is provided, PJM will add a condition precedent in the GIA requiring that within 180 days of the effective date of the GIA, 100% Site Control be acquired for at least one or three years, as applicable, from the last day of Phase III. If 100% Site Control is not obtained within 180 days of the effective date of the GIA, then the project will automatically be deemed terminated and will be withdrawn from the Cycle.

The following Table outlines the Site Control term requirement in a Cycle.

		Site Control Term		
		Generating Facility	Interconnection Facility	Interconnection Switchyard
Submission 1 Application Phase	Full	 100% Deed Lease Option (See Note 1)	<i>Not Required</i>	<i>Not Required</i>
Term Requirement		1 year from Application Deadline		
Submission 2 Decision Point 1 (See Note 2)	Partial	 100% Deed Lease Option	 50% Deed Lease Option Right-of-Way	 50% Deed Lease Option
Term Requirement		1 year from last day of Phase 1		
Submission 3 Decision Point 3  (See Note 3)	Full	 100% Deed Lease Option	 100% Deed Lease Option Right-of-Way	 100% Deed Lease Option (See Note 4)
Term Requirement		Additional 1 year from last day of Phase 3 (for Transition Cycles #1 and #2) Additional 3 years from last day of Phase 3 (for new Cycle)		



 = 100% Site Control Required
  = 50% Site Control Required

Exhibit 25: Site Control Term Requirements

The following notes apply to the Site Control Term Requirements table above:

Note 1: Merchant Transmission projects need to demonstrate 100% Site Control for Transmission Substation Facility (e.g. HVDC converter station, phase angle regulator (PAR), and/or variable frequency transformer (VFT)) up front in Application Phase. (The Transmission line not included).

Note 2: Projects that are eligible for an accelerated process to receive their final interconnection-related agreement at Decision Point I or Decision Point II will be required to provide full Site Control for an additional one or three year term (as applicable) from the last day of Phase I or Phase II, respectively.

For a non-jurisdictional project, eligible for an accelerated process to receive their final interconnection-related agreement, the Project Developer must provide Site Control evidence that extends through full execution date of the relevant state level interconnection agreement with the applicable entity, plus one year (for New Service Requests in Transition Cycles #1 or #2) or three years (for New Service Requests in the new Cycle), as applicable, beyond such full execution date of the relevant state level interconnection agreement with the applicable entity.

If a Project Developer fails to produce all required Site Control evidence at the time it is accelerated, it must show concrete evidence acceptable to PJM that it is in negotiations to achieve 100% of all required Site Control, and PJM will add a condition precedent to the final interconnection-related agreement requiring that such Site Control be achieved within 180 days from the effective date of the final agreement.

If 100% Site Control is not obtained within 180 days of the effective date of the final interconnection-related agreement, then the project will automatically be deemed terminated and will be withdrawn from the Cycle.

Note 3:

If 100% Site Control is not obtained by Decision Point III, then Project Developer must show concrete evidence acceptable to PJM that it is in negotiations to achieve 100% of all required Site Control for a period of at least one year (for New Service Requests in Transition Cycles #1 or #2) or three years (for New Service Requests in the new Cycles), as applicable, from the last day of Phase III, and PJM will add a condition precedent to the final interconnection-related agreement requiring that within 180 days of the effective date of such agreement, 100% Site Control be acquired for at least one or three years, as applicable, from the last day of Phase III.

If 100% Site Control is not obtained within 180 days of the effective date of the final interconnection-related agreement, then the project will automatically be deemed terminated and will be withdrawn from the Cycle.

Note 4:

Project Developer must be in compliance with Interconnection Transmission Owner's ultimate ownership requirements for the Interconnection Switchyard.

7.2.5 Post-WMPA/GIA Modification Procedures

For any changes to the Site as included in Schedule A of an executed WMPA/GIA the following requirements must be met:

- Any change does not impact the timing of milestones or Transmission Owner construction schedule.
- Project Developer provides an attestation that the Site modification will have no impact on the overall timing of milestones and backfeed. This attestation will include acknowledgment that the Project Developer waives the ability to request future milestone extensions related to permits or other land issues. Please contact your PJM project manager for the latest attestation template if required.
- In the event a change would impact modeling assumptions, the Project Developer would need to enter into a Necessary Studies Agreement. A necessary study would then be performed to determine if the proposed modification would result in a permanent material impact to the Transmission System and determine any modifications required to accommodate the modification.

Section 8: Summary of Agreements

Section 8 provides an overview of interconnection related service agreements.

8.1 Summary of Tariff Agreements

The agreements included in Tariff Part IX are listed in the table below.

Agreement	Tariff Form
Application and Studies Agreement	Part IX, Subpart A
Generation Interconnection Agreement Combined with Construction Service Agreement	Part IX, Subpart B
Wholesale Market Participation Agreement	Part IX, Subpart C
Engineering and Procurement Agreement	Part IX, Subpart D
Upgrade Construction Service Agreement	Part IX, Subpart E
Cost Responsibility Agreement	Part IX, Subpart F
Necessary Study Agreement	Part IX, Subpart G
Network Upgrade Cost Responsibility Agreement	Part IX, Subpart H
Surplus Interconnection Service Study Agreement	Part IX, Subpart I
Construction Service Agreement	Part IX, Subpart J
Upgrade Application and Studies Agreement	Part IX, Subpart K
Affected System Customer Facilities Study Application and Agreement	Part IX, Subpart L

Exhibit 26: Summary of Tariff Agreements

Further information on all terms and conditions to be incorporated and made part of each Tariff form of interconnection related agreement may be found in the Tariff Sections noted above.

8.2 General Agreement Execution Deadlines

Pursuant to Tariff, Part IX, Section 500, Execution Deadlines, unless otherwise stated in a specific agreement, the following provisions shall apply to any agreement under Tariff, Part IX,

between PJM, a Project Developer, Eligible Customer or Upgrade Customer, and, where applicable, a Transmission Owner.

In addition to any other requirements under such agreement, no later than 15 Business Days after PJM tenders for execution of such agreement, Project Developer, Eligible Customer or Upgrade Customer, shall either:

1. execute the agreement;
2. request in writing dispute resolution as allowed under Tariff, Part I, section 12 or, if concerning the Regional Transmission Expansion Plan, consistent with Operating Agreement, Schedule 5; or
3. request in writing that the agreement be filed unexecuted with FERC.

Such agreement shall be deemed to be terminated and withdrawn if Project Developer, Eligible Customer or Upgrade Customer, fails to comply with these requirements.

If a Transmission Owner is party to the agreement, following tender of the agreement and no later than 15 Business Days after PJM sends notification to the relevant Transmission Owner that the Project Developer, Eligible Customer or Upgrade Customer has executed the agreement, Transmission Owner shall either:

1. execute the agreement;
2. request in writing dispute resolution as allowed under Tariff, Part I, section 12 or, if concerning the Regional Transmission Expansion Plan, consistent with Operating Agreement, Schedule 5; or
3. request in writing that the agreement be filed unexecuted with FERC.

Following execution by Transmission Owner (or by the Project Developer if there is not Transmission Owner that is subject to the agreement) PJM shall either:

1. execute the agreement;
2. request in writing dispute resolution as allowed under Tariff, Part I, section 12 or, if concerning the Regional Transmission Expansion Plan, consistent with Operating Agreement, Schedule 5; or
3. file with FERC the agreement in unexecuted form. PJM may also file the agreement with FERC in unexecuted form if Transmission Owner does not comply with the requirements above.

With the filing of any unexecuted agreement, PJM may, in its discretion, propose to FERC a resolution of any or all of the issues in dispute between the parties.

8.3 Summary of Non-Tariff Agreements

The following PJM agreements discussed in this section are not included in Tariff Part IX.

Agreement	Location
Consent to Assignment Agreements	PJM Website
Agreement to Amend	Drafted by PJM

Exhibit 27: Summary of Non-Tariff Agreements

8.4 Agreements to Initiate Interconnection Related Request

8.4.1 Application and Studies Agreement (ASA)

This agreement is used to initiate studies for the following requests:

- Generation Interconnection Requests
- Transmission Interconnection Requests
- Long Term Firm Transmission Service requests for a period extending beyond the 18 month Available Transmission Capacity (ATC) horizon

Prior to the Application Deadline, Project Developers and Eligible Customers must electronically provide to PJM through the PJM data submission tool or OASIS, as applicable, all necessary information for the ASA which is then subject to validation during the application review portion of the Application Phase. Only valid New Service Requests will proceed past the Application Phase.

Section 2 of this manual provides more detail on the ASA requirements.

8.4.2 Upgrade Application and Studies Agreement (UASA)

Upgrade Customers requesting to (i) fund Network Upgrades or seek certain Incremental Auction Revenue Rights or (ii) upgrade facilities or advance already-identified upgrades, must submit an Upgrade Application and Studies Agreement.

Upgrade Requests are processed serially, based on the order in which PJM receives them.

Section 11 of this manual provides more details on requirements for Upgrade Requests.

8.4.3 Affected System Customer Facilities Study and Application Agreement

An Affected System Customer Facilities Study and Application Agreement is used to initiate an Affected System Customer Facilities Study when an interconnection on an adjacent transmission system causes an impact on the PJM Transmission System.

Section 13 of this manual provides more detail on requirements for Affected System Customer Facilities Studies.

8.4.4 Surplus Interconnection Service Study Agreement (SISSA)

The Surplus Interconnection Service Study Agreement is used to initiate requests for Surplus Interconnection Service. Surplus Interconnection Service Requests are processed serially, based on the order in which PJM receives them.

Section 12 of this manual provides more detail on requirements for Surplus Interconnection Requests.

8.4.5 Engineering and Procurement Agreement (E&P Agreement)

The Engineering and Procurement Agreement (E&P Agreement) is the agreement that expedites, at a Project Developer's request, the engineering and procurement of certain long lead time items necessary for the establishment of the interconnection. An E&P Agreement is not intended to be used for the actual construction of any Interconnection Facilities or Network Upgrades. An E&P Agreement can only be requested by a Project Developer, and can only be requested in Phase III.

If an E&P Agreement is used, the subsequently executed GIA will supersede the E&P Agreement in place for that facility.

8.4.6 Cost Responsibility Agreement (CRA)

A Project Developer, who owns and operates an existing Generation Facility within the PJM Region and is currently party to an existing agreement with a Transmission Owner that is not a three-party GIA among PJM, Project Developer, and Transmission Owner, may request PJM to perform modeling, studies or analysis to verify and ensure that the interconnection of the Generating Facility meets necessary system interconnection requirements specified in the PJM Tariff and associated PJM Manuals, as appropriate.

In order to make such a request, a Cost Responsibility Agreement must be fully executed between PJM and the Project Developer, and the Project Developer must provide a deposit of \$10,000 to PJM. The Project Developer will be responsible for the actual costs incurred by PJM and the Transmission Owner to perform such studies.

Once the studies are completed and it is confirmed that the interconnection of the Generating Facility meets necessary system interconnection requirements, PJM will issue a new three-party non-Cycle GIA among PJM, the Project Developer and the Transmission Owner.

Section 14 of this Manual provides more detail on requirements for existing PJM Generating Facility owners to convert existing agreements from two-party non-PJM agreement to three-party PJM GIAs.

8.5 Final Agreements

8.5.1 Generation Interconnection Agreement (GIA)

After the project's required study work is completed, PJM will tender a Generation Interconnection Agreement ("GIA") to be executed by the Project Developer, the Transmission Owner, and PJM. The GIA defines the obligations of the Project Developer regarding cost responsibility for any required system upgrades. The GIA also confers the rights associated with the interconnection of a Generating Facility as a Capacity Resource and any operational restrictions or other limitations on which those rights depend.

For Transmission Project Developers, the GIA confers transmission injection and withdrawal rights (Merchant Direct Current and/or Fully Controllable Alternating Current transmission projects) and applicable incremental delivery rights and Incremental Auction Revenue Rights.

The GIA further identifies any changes in construction responsibility from the Standard Option for Transmission Owner Interconnection Facilities due to the Project Developer exercising the Negotiated Contract Option or Option to Build.

8.5.1.1 Pre-GIA Information Requirements

In order to proceed with a GIA, within 30 days after receipt of the Phase III System Impact Study (or, if no Phase III System Impact Study was required, then after the results of either the Phase I or Phase II System Impact Study were provided on PJM's website), the Project Developer must demonstrate the following:

- Fuel delivery agreement and Water agreement – Project Developer must demonstrate it has entered into a fuel delivery agreement and water agreement, if necessary, and that it controls any necessary rights-of-way for fuel and water interconnection.
- Local, county, and state site permits agreement – Project Developer must obtain all necessary local, county, and state site permits.
- Memorandum of understanding – Project Developer must demonstrate a signed memorandum of understanding for the acquisition of major equipment.
- Permits for Merchant D.C. Transmission Facilities or Merchant Controllable A.C. Transmission Facilities - obtained any necessary local, county, and state siting permits or other required approvals for the construction of its proposed facility.

If the pre-GIA milestones have not been met at the time of the GIA execution, milestones may be established within the GIA, as applicable.

8.5.1.2 GIA Project Milestones

Project milestones are defined in section 6 of the GIA. Milestones are project requirements that provide critical measuring points which, when not met, can result in Breach of the GIA.

GIA typically include the standard project milestones listed below, but milestones can be added to customize the agreement to suit the needs of all involved parties.

- The Project Developer must maintain compliance with pre-GIA milestones as stated in PJM Tariff, Part VII, Subpart D, Sections 309, 311, and 313, and Subpart E, Section 331 and PJM Tariff, Part VIII, Subpart C, Sections 406, 408, and 410, and Subpart E, Section 429.
- Substantial site work – The Project Developer is to demonstrate that 20% of site work is complete by the specified date. Additionally, the Project Developer must submit certified drawings of the Project Developer Interconnection Facilities to the Transmission Owner and PJM for their review.
- Delivery of major electrical equipment – The Project Developer must demonstrate that all of the major electrical material has been received at the project site by the milestone date.
- Commercial operation – The Project Developer must make a commercial sale into PJM's wholesale market of the project's energy output or demonstrate the use of the facility's energy output by the milestone date.
- As-Built documentation – The Project Developer must provide certified documentation and electrical modeling data as required for verifying that the facilities constructed align with the PJM studies and agreements.

Project Developers may request milestone extensions for delays that were outside of their control and that could not have been avoided by exercising due diligence per PJM Tariff, Part VII, Subpart E, section 331(B)(3) and Tariff, Part VIII, Subpart E, section 429(B)(3).

Project Developers will also have a one-time option per PJM Tariff, Part VII, Subpart E, section 331(B)(4) and Tariff, Part VIII, Subpart E, section 429(B)(4) to extend any milestone (other than any milestone related to Site Control) for a total period of one year regardless of cause. Other milestone dates stated in the GIA shall be deemed to be extended coextensively with Project Developer's use of this one-time option.

8.5.1.3 Rights

The rights Project Developers may be granted under a GIA are found in the GIA, Specifications section 2.0.

1. **Capacity Interconnection Rights** - Any Capacity Interconnection Rights granted to the Generation Interconnection project will be detailed in GIA, Specifications section 2.0.
2. **Interim Capacity Interconnection Rights** - If a project reaches commercial operation prior to the date its Capacity Interconnection Rights become effective or before completion of all required Network Upgrades, the Project Developer may request that PJM perform an interim deliverability study. Depending on the results of such study, PJM may grant interim Capacity Interconnection Rights that will be in effect only for the delivery year studied.

3. **Injection/Withdrawal Rights** - Any firm or non-firm Transmission Injection or Withdrawal Rights from PJM's transmission system via Merchant D.C. or controllable A.C. transmission facilities will be detailed in GIA, Specifications section 2.0. Interim Transmission Injection Rights are granted through the same process as detailed above for interim Capacity Interconnection Rights.

8.5.1.4 Interconnection Construction Terms and Conditions

The standard terms and conditions for construction of Interconnection Facilities are incorporated within the GIA, Schedule L. This encompasses construction as it relates to Common Use Upgrades, Distribution Upgrades, Network Upgrades, Stand Alone Network Upgrades, and/or Transmission Owner Interconnection Facilities and the coordination of the construction and interconnection of an associated Generating Facility

These terms and conditions address the following items:

- Project scope
- Construction responsibilities of the parties
- Ownership of Transmission Owner and Project Developer Interconnection Facilities
- Schedule of major construction work
- Details on how the construction will be performed

In cases in which there are multiple affected Transmission Owners, a separate stand-alone Construction Service Agreement (CSA) located in Tariff Part IX, Subpart J, will be executed with each such Transmission Owner.

8.5.1.5 Applicable Technical Standards

PJM will ensure that the Generation and/or Transmission Project Developer has access to the Applicable Technical Requirements and Standards of the Transmission Owner(s) for parallel operation of Generating Facilities with the Transmission Owner(s) systems and other matters generally included in good utility practice. Technical requirements for Generation and Transmission interconnections include but are not limited to:

- Engineering design requirements and standards
- Interconnection protection requirements
- Generator under-frequency trip settings to coordinate with automatic under-frequency load shedding schemes
- Voltage control and reactive output requirements (Tariff at Part IX Subpart B, GIA Appendix 2 Section 4.6)
- Data and control requirements for transmission system operation
- Equipment specifications and suppliers
- Construction requirements and standards
- Engineering, procurement and construction process requirements and standards

- Interconnection substation acreage requirements

Applicable Technical Requirements and Standards for each Transmission Owner are available on the PJM website.

PJM will file the GIA in compliance with applicable FERC guidelines. If the Project Developer has requested dispute resolution or filing of the GIA unexecuted, construction of facilities and upgrades shall be deferred until any disputes are resolved or the Commission has accepted the unexecuted GIA for filing, unless otherwise agreed by the Project Developer and the affected Transmission Owner(s).

8.5.2 Construction Service Agreement (CSA)

A stand-alone Construction Service Agreement (CSA) may be implemented in circumstances in which Network Upgrades to the system of a Transmission Owner are required to accommodate the Interconnection Request of a Project Developer, whose facilities do not directly interconnect to the Transmission Owner's system. Examples include Project Developers who are Affected System Customers (external to the PJM region), that require Network Upgrades to be constructed by PJM Transmission Owners, or Project Developers requiring upgrades to be constructed by PJM Transmission Owners, other than their interconnecting Transmission Owner.

Unless security has already been provided under a separate GIA, prior to the effective date of the CSA, the Project Developer shall provide Security to PJM (for the benefit of the Transmission Owner), which is calculated as the total estimated costs of the Network Upgrades as specified in the agreement. The CSA binds the Project Developer to the actual costs of the Network Upgrades, whether greater or lesser than the amount of the security provided.

8.5.3 Upgrade Construction Service Agreement (UCSA)

An Upgrade Customer who proposes to make an upgrade to an existing transmission facility or who seeks Incremental Auction Revenue Rights (IARRs) and (Incremental Capacity Transfer Rights (ICTRs) will receive an Upgrade Construction Service Agreement ("UCSA") after its study process is completed.

The terms and conditions of a UCSA govern the construction activities associated with the upgrade of capability on the PJM bulk electric system in order to accommodate an Upgrade Request. Facilities constructed under an UCSA are not owned by an Upgrade Customer. All ownership rights of the physical facilities are retained by the relevant Transmission Owner following the completion of construction. PJM and the Upgrade Customer execute a separate UCSA with each affected Transmission Owner. An Upgrade Customer retains the right, but not the obligation ("Option to Build"), to design, procure, construct and install all or any portion of the Customer Funded Upgrades. The form for the UCSA can be found in the PJM Tariff, Part IX, Subpart E.

8.5.4 Network Upgrade Cost Responsibility Agreement (NUCRA)

The Network Upgrade Cost Responsibility Agreement (NUCRA) refers to the agreement entered into by two or more Project Developers and PJM, relating to construction of Common Use Upgrades (Network Upgrades needed for the interconnection of Generating or Merchant Transmission Facilities for more than one Project Developer that share cost responsibility) and coordination of the construction and interconnection of associated Generating Facilities. A separate NUCRA will be executed for each set of Common Use Upgrades on the system of a specific Transmission Owner that is associated with the interconnection of a Generating Facility or Merchant Transmission Facility.

The NUCRA includes the identified Common Use Upgrades scope and schedule of work, the cost responsibility for the Project Developers that share cost responsibility, as well as the terms and conditions for the agreement.

8.5.5 Wholesale Market Participation Agreement (WMPA)

Project Developers interconnecting to non-FERC jurisdictional facilities who intend to participate in the PJM wholesale market will receive a three party agreement known as a WMPA. The WMPA is essentially a GIA without interconnection provisions, and facilitates the wholesale sale of MWs from such facilities.

8.6 Additional Requirements for Final Agreements

8.6.1 Security Requirement

Project Developers and Eligible Customers, pursuant to PJM Tariff, Part VII, Subpart D, sections 309, 311 and 313 and Part VIII, Subpart C, sections 406, 408 and 410, are required to provide Security in a form acceptable to PJM at the Decision Point which runs concurrently with the project's Final Agreement Negotiation Phase. Security may be adjusted after PJM tenders the final service agreement draft, to incorporate impacts of any withdrawn projects during that same Decision Point.

Any required Security adjustments must be provided within 15 Business Days after receiving the applicable final service agreement.

Security may be in the form of cash, letter of credit, or other form of Security acceptable to PJM that names PJM as the beneficiary for any work required and specified in the agreement.

PJM requires Security to be held in order to:

- Protect Transmission Owner(s) and ratepayers in the event the Project Developer fails to pay for any work performed by the Transmission Owner(s) and terminates their project. The Security will allow the Transmission Owner(s) to ensure system reliability by completing the work.

- Protect other New Service Customers in the event the Project Developer terminates the project after executing a NUCRA, GIA, EPA, WMPA, or UCSA when another New Service Customer is relying on those facilities. The Security would cover the cost of the Transmission Owner(s) to complete the required Network Upgrades that other New Service Customers need.

The Security amount is calculated as the full costs of work allocated to the project in their respective final service agreement.

If a Project Developer fails to timely execute the applicable final agreement(s), meet the applicable Tariff milestones identified in the final agreement(s), or provide the required Security, the Interconnection Request will be deemed terminated and withdrawn.

8.6.2 Option to Build Requirements

Project Developer has the option (“Option to Build”) to assume responsibility for the design, procurement, and construction of Transmission Owner Interconnection Facilities and Stand Alone Network Upgrades on the dates specified in the Schedule of Work in section 8.0 of the GIA Schedule L .

PJM and the Project Developer must agree as to what constitutes Stand Alone Network Upgrades and identify the Stand Alone Network Upgrades in the Specifications portion of the GIA.

If PJM and the Project Developer disagree about whether a particular Network Upgrade is a Stand Alone Network Upgrade, PJM must provide the Project Developer with a written technical explanation outlining why PJM does not consider the Network Upgrade to be a Stand Alone Network Upgrade within 15 days of its determination. Except for Stand Alone Network Upgrades, the Project Developer shall have no right to construct Network Upgrades under the Option to Build.

In order to exercise this Option to Build, the Project Developer must provide PJM and the Transmission Owner with written notice of Project Developer’s election to exercise the option consistent with the deadline applicable to its New Service Request or Upgrade Request.

- For New Service Requests, the Project Developer must elect the Option to Build within 30 days of receipt of the Phase II System Impact Study (Decision Point II).
- For Upgrade Requests, the Upgrade Customer must elect the Option to Build within 30 days of receipt of the System Impact Study.

If exercising the Option to Build, the Project Developer or Upgrade Customer must select contractors to perform such work from the Transmission Owner’s “List of Approved Contractors”. Each Transmission Owner’s “List of Approved Contractors” is available on the PJM website. If a contractor the Project Developer or Upgrade Customer desires to use is not on the “List of Approved Contractors,” the Project Developer or Upgrade Customer can request the Transmission Owner evaluate the contractor for acceptability. The design and construction of

the Transmission Owner Interconnection Facilities pursuant to Option to Build must adhere to the Transmission Owner's Applicable Technical Requirements and Standards.

Additional Option to Build implementation details and timelines are captured in GIA Schedule L, UCSA and PJM Manual 14C.

8.6.3 Operations in advance of the study year or the required system reinforcement

In order to allow rights to be exercised in advance of the base case year in which they are studied or prior to completion of construction of a required system reinforcement, interim deliverability studies are performed.

It is incumbent upon a Project Developer wishing to exercise rights in the PJM Market prior to their base case year or prior to the completion of required Network Upgrades to request interim deliverability studies through their assigned PJM project manager.

Section 4 of this Manual provides additional information on interim deliverability studies.

8.7 Modifying Interconnection Related Agreements

8.7.1 Consent to Assignments

Prior to transferring ownership of a project or company, a Project Developer or Transmission Owner must complete an applicable "consent to assignment agreement." PJM has established templates for consent to assignment agreements at the following stages of development and operation:

8.7.1.1 Assignment prior to the final agreement

Prior to the EPA, GIA, WMPA or UCSA being executed, a customer should work with their assigned PJM project manager to complete the appropriate form of agreement located on pjm.com. Two methods for assignment prior to the final agreement have been developed:

- 1) buyer and seller enter a combined agreement; or
- 2) buyer and seller each separately complete agreements.

Assignment after the final agreement is detailed in Manual 14C.

8.7.2 Agreement to Amend

Project Developers with existing GIAs may at times need to modify the agreement to reflect changes to their facility or changes in ownership. An Agreement to Amend is used to memorialize such changes. The Agreement to Amend is executed by all parties to the GIA. Project Developers may be required to enter into a Cost Responsibility Agreement (Tariff Part

IX, Subpart F) with PJM before PJM will commence any work related to the Agreement to Amend.

8.7.3 Necessary Study Agreement

A Project Developer that has entered into a GIA that plans to undertake modifications pursuant to that GIA will be required to enter into a Necessary Study Agreement (NSA). The NSA provides the terms, conditions, Study Deposit, and cost responsibility for the Project Developer to pay PJM's actual costs to perform the Necessary Study(ies) to determine:

1. the type and scope of the permanent material impact, if any, the change will have on the Transmission System
2. the additions, modifications, or replacements to the Transmission System required to accommodate the change
3. a good faith estimate of the cost of the additions, modifications, or replacements to the Transmission System required to accommodate the change.

Additional NSA requirements are captured in PJM Manual 14C.

Section 9: Generator Interconnection Requirements, Rights and Obligations

Section 9 identifies requirements, rights and obligations for generators that desire to participate in the PJM Capacity market. This section will provide the generator with guidance on electing Capacity Resource or Energy Resource status, power factor requirements and transferring Capacity rights.

This section also includes an overview of New Jersey Off-Shore Wind State Agreement Approach (SAA) Capability and how it is considered in the System Impact Study, and addresses how PJM handles changes to existing or proposed Generating Facilities, modifications to New Service Requests and multiple New Service Requests behind the same Point of Interconnection.

9.1 Requirements for Generating Facilities

Under the definition of Generation Capacity Resource in the Tariff and Reliability Assurance Agreement (RAA), Capacity Interconnection Rights are awarded to a Generating Facility as a result of its Interconnection Request. While some technologies, such as wind, solar, hydro, and combined cycle facilities may participate in the Capacity Market through the aggregation of multiple generating units (see, for example, the Capacity market participation requirements in PJM Manual 21), PJM must be able to model each machine that can participate as a generator in its planning process.

9.2 Generator Power Factor Requirements

All generators interconnected with the PJM Transmission System shall be designed to maintain a composite power delivery at continuous rated power output and reactive capability in accordance with the power factor requirements stated in the Tariff. (Tariff at Part IX, Subpart B, App. 2, Section 4.6.1)

For new Generating Facilities interconnecting to the PJM Transmission System, Project Developers shall design the Generating Facility to maintain a power factor as described in the table below:

Generator Type	Size	Required PF	Measure Point
Synchronous	20 MW or less	0.95 lead to 0.9 lag	Point of Interconnection
Synchronous	More than 20 MW	0.95 lead to 0.9 lag	Generator terminals

Wind and non-synchronous	Any	0.95 lead to 0.95 lag	High-side of facility sub transformer
--------------------------	-----	-----------------------	---------------------------------------

Exhibit 28: Generator Power Factor Requirements

9.3 Application of Power Factor Requirements to Increases of Existing Generation

Power Factor requirements for increases in to capacity or energy increases to existing or planned generation as set forth in Tariff Part IX, Subpart B, App. 2, Section 4.6.1.1.2.

Generator Type	Size	Required PF	Measure Point
Synchronous	20 MW or less	1.0 lead to 0.9 lag	Point of Interconnection
Synchronous	More than 20 MW	1.0 lead to 0.9 lag	Generator terminals
Wind and non-synchronous	Any	0.95 lead to 0.95 lag	High-side of facility sub transformer

Exhibit 29: Generator Power Factor Requirements for Increases to Existing Generation

9.3.1 Legacy Megavolt Ampere (Mvar) Capability

Increases to existing Generating Facilities must be designed to maintain the Mvar capability for the existing and pre-upgraded gross generator output capability and the Tariff Part IX, Subpart B, App. 2, Section 4.6.1.1.2 power factor requirement for all incremental MW increases.

Legacy Mvar capability will be determined using the following methodology and considerations.

- If an agreement exists and contains a reference to required Mvar capability, the methodology in the agreement will determine the Mvar capability.
- Consideration will be given to the potential interpretations of the language in the agreement. Non-standard or vague terms and conditions will be discussed by PJM and the parties named in the agreement.
- If no agreement exists or there is no reference to required Mvar capability in an existing agreement, PJM will use alternate methods to determine the Mvar capability of the machine.
- Examples of potential alternate methods that may be used at PJM's discretion:
 - Use of the D-Curve provided by the manufacturer and on file with PJM.
 - Review of the data with the Generating Facility owner with an opportunity for the Generating Facility owner to provide additional analytical evidence as to the actual Mvar capability, if different from the manufacturer design data.

- Consideration of available test data with acknowledgement that tests are not always performed under ideal conditions and the system may limit the capability during testing. Input from the Generating Facility owner will also be considered as part of the evaluation by PJM.
- Consideration of historical operational data.

9.4 Electing Capacity Resource Status versus Energy Resource Status

A Project Developer must elect the status type for the generating capability associated with each interconnection request: Capacity Resource Status or Energy Resource Status. A Capacity Resource status designation permits the generator to be utilized by PJM Load Serving Entities to meet Capacity obligations under the terms of the RAA, available in the [Library](#) section of PJM's website.

Capacity and Energy Resources for New Service Requests are evaluated in the same manner as existing generators as explained in Manual 14B.

9.4.1 Capacity Resource Status:

Units must meet certain interconnection requirements to be designated as Capacity Resources. Capacity Resource status is granted based on the availability of sufficient transmission capability to ensure the deliverability of generator output to network load and to satisfy the regional reliability requirements of the NERC region in which the generator is located – ReliabilityFirst or SERC. Specific analytical tests performed during the System Impact Study(ies) reveal the specific transmission system upgrades required to meet these reliability criteria.

Capacity Resource Status conveys specific Capacity Interconnection Rights enabling a Generating Facility to participate in PJM Capacity markets. Technologies, such as wind, solar, hydro, and combined cycle facilities may participate in the Capacity Market through the aggregation of multiple generating units. Refer to the Capacity market participation requirements in PJM Manual 21.

9.4.2 Energy Resource Status:

The planning studies for Generating Facilities seeking Energy Resource status require deliverability analyses that are different from studies for units seeking Capacity Resource status. As such, Energy Resource units are only permitted to participate in the PJM energy markets. Such units do not receive Capacity Interconnection Rights and may not participate in the PJM Capacity markets.

9.5 Transfer of Capacity Interconnection Rights (CIRs)

In order for the holder of Capacity Interconnection Rights to transfer rights under Tariff Part VII, Subpart E, section 328 and Part VIII, Subpart E, section 426, the holder of the rights must have:

- constructed all necessary system upgrades identified in the GIA or WMPA, and
- maintained the rights as required by the Tariff.

9.5.1 Transfer of CIRs Prior to Commercial Operation

CIRs under study or CIRs from an ISA or GIA associated with a facility or unit(s) that have not become commercial are non-transferrable.

9.5.2 Transfer of CIRs from an Operating Unit

For existing Capacity Resources that wish to transfer CIRs and that meet the requirements identified above, a letter to PJM must be provided by the assignor of the CIRs indicating the amount of CIRs to be transferred and the entity to which the CIRs are to be transferred (assignee). Refer to PJM.com for a template CIR transfer letter.

The assignee of the CIRs must be able to meet all Tariff operating requirements. The assignee also must submit a new Generation Interconnection Request so that PJM can verify that the unit receiving the CIRs is capable of meeting all requirements (e.g., power factor requirements) at the new CIR level.

Transfers of CIRs will be evaluated through System Impact Studies performed by PJM (including load flow, short circuit and stability).

9.5.3 Transfer of CIRs from a Deactivated Unit

If the owner of an existing generating unit that is to be deactivated wants to transfer its CIRs to a new unit, they must submit a new Generation New Service Request within one year of deactivation. Failure to submit a new Generation New Service Request within one year of the deactivation will result in the loss of the CIRs.

If the CIRs are to be transferred to another owner, a letter to PJM must be provided by the assignor of the rights indicating the amount of CIRs to be transferred and the entity to which the rights are to be transferred (assignee). Refer to PJM.com for a template CIR transfer letter.

The assignee of the CIRs must submit a Generation New Service Request within one year of the deactivation of the transferring unit. The Project Developer must submit any claim for CIRs from deactivating units concurrently with the Generation Interconnection Request, and the claim must be received by PJM prior to the Application Deadline for the next Cycle.

Transfers of CIRs will be evaluated through System Impact Studies performed by PJM (including load flow, short circuit and stability).

9.6 State Agreement Approach (SAA) Capability

9.6.1 Award of SAA Capability to a New Jersey OSW Generator or Other Public Policy Resource

Subject to the terms of the SAA Agreement filed under FERC Docket ER23-775, NJBPU-selected offshore wind (OSW) generators or other NJBPU-selected Public Policy Resources may be eligible to be granted SAA Capability, subject to the evaluation of the associated New Service Request. PJM will perform the OSW Generator's respective System Impact Study utilizing the SAA Capability assigned to the OSW Generator through the OSW Solicitation.

Note:

SAA Capability is applicable up to the full MFO value.

9.6.2 Eligibility to Receive Capacity Interconnection Rights (CIRs) When Studied with SAA Capability

In order for the holder of SAA Capability to be granted CIRs through the New Service Request study process, the holder of the SAA Capability must have completed the following:

- constructed all necessary system upgrades identified in the GIA, and
- maintained the rights as required by the Tariff.

9.6.3 Granting of SAA Capability

The Project Developer that is granted SAA Capability from the NJBPU and wishes to be studied using the SAA Capability must submit any SAA Capability claim concurrently with the Generation New Service Request, and the claim must be received by PJM prior to the Application Deadline for that Cycle.

Transfers of CIRs will be evaluated through System Impact Studies performed by PJM (including load flow, short circuit and stability).

9.6.4 CIR Transfer/SAA Capability Study Process

In all cases the transfer of CIRs or study of SAA Capability will require the Project Developer or owner of the CIRs to submit a Generation Interconnection Request. There could be instances where CIRs are being transferred to different Point of Interconnection from the original location. Similarly, SAA Capability could be granted to a different Point of Interconnection from the original study location. These transfers will require System Impact Studies (for load flow, short circuit and stability) to determine if the transferred CIRs or SAA Capability assignment contribute to or cause the need for a new system reinforcement(s).

The following processes will be used to determine if the transfer injections at the new Point of Interconnection will cause any new overloads or contribute to existing overloads.

9.6.4.1 Load Flow

For the study of the transfer of CIRs, or assignment of SAA Capability, as it affects thermal constraints, all load flow studies will be performed on the model for the Cycle in which the Generation Interconnection Request was submitted. All projects in the Cycle will be modeled and considered. The evaluation will move the injections from the existing Point of Interconnection to the new Point of Interconnection in the Generation Interconnection Request to determine the thermal impacts. If the new Generation Interconnection Request contributes to an overload(s), loading on the overloaded elements is compared to the loading prior to the transfer to the new Point of Interconnection.

The MW contribution for cost allocation purposes for the new Generation Interconnection Request will only be based on the difference of the element loading due to the Point of Interconnection move, and not the full contribution of the new Generation Interconnection Request.

For example, if the existing unit or SAA Capability that is granted was contributing 45 MW to the overloaded flowgate but when the CIRs or SAA Capability are transferred, the new project contributes 50 MW, the new project will only receive cost allocation based on the 5 MW difference in contribution, not the full 50 MW contribution. This analysis will insure that any CIRs owned by the existing generator or SAA Capability will be used by the new Generation Interconnection Request.

Note: Refer to Cost Allocation rules in Attachment B to this manual.

9.6.4.2 Short Circuit

For the study of short circuit impacts to the system, studies will be performed in order to determine the impact on the increase in fault current for all facilities associated with any new Generation Interconnection Request.

The short circuit contribution for cost allocation purposes for the new Generation Interconnection Request will be based only on the difference of the fault current between the existing and New Service Request. For example, if the existing unit or SAA Capability that is granted was contributing 1000 amps to the overdutied facility but new project contributes 1200 amps, the new project will only receive cost allocation based on the 200 amp difference in contribution, not the full 1200 amp contribution. If the New Service Request contributes less than 1000 amps, it will not have cost allocation for a reinforcement.

9.6.4.3 Stability

Dynamic stability studies will be performed in order to determine the impact of the new Generation Interconnection Request. If any new stability issues are identified, the Generation Interconnection Request will have cost allocation for a system reinforcement.

The existing unit or SAA Capability generator would not be dispatched during the study of the new Generation Interconnection Request if all CIRs or SAA Capability are claimed. For partial

claims, the existing generator or SAA Capability generator may also be dispatched based on the amount requested in the new Generation Interconnection Request.

9.7 Changes to Existing or Proposed Generation/Transmission Facilities

A Project Developer shall submit to PJM in writing any modification to its project that causes the project's Capacity, location, configuration or technology to differ from any corresponding information provided in the New Service Request. An existing or proposed Generating Facility may request changes which will require consideration under PJM's New Service Request process.

9.7.1 New Ownership Requirements:

If a Generating Facility is acquired by a new owner, then the responsibilities and rights in the PJM Market for the transferred facility will be transferred to the new owner following notification to PJM by the selling and purchasing entities. Transfer of ownership of existing Generating and Transmission Facilities is not subject to the interconnection process unless pre-existing CIRs for the facilities are not transferred to the new owner.

A Project Developer can also transfer ownership of New Service Request. (See "Consent to Assignments" in Section 8 of this Manual).

9.7.2 Unit Output Increases:

If a Generation Owner plans to increase the Maximum Facility Output (MFO) or the amount of Capacity Interconnection Rights (CIRs) of an existing generating unit or active Generation Interconnection Request to a MW value greater than the amount already specified in a Generating Facility's existing ISA or GIA or active New Service Request, then the additional MFO or CIRs will be treated as a new Generation Interconnection Request. The increase in MFO or CIRs will be evaluated under the same study procedure as a New Service Request.

9.7.3 Electrical Characteristics Changes:

There are two scenarios where the electrical characteristics of a generator may request to be changed from what was previously studied by PJM without increasing the original MFO or CIRs:

(i) A Generation Owner may desire to change the electrical characteristics of their existing Generating Facility or Generation Interconnection Facilities; or

(ii) A New Service Request with a signed ISA or GIA may desire to change the electrical characteristics of their planned Generating Facility or Project Developer Interconnection Facilities.

In either of the case, the Generation Owner or Project Developer must request that a Necessary Study be performed by PJM (see PJM Tariff Part IX Subpart B, Appendix 2, Section 3.4.1).

9.7.4 Reductions or Deactivations/Retirements

Owners of existing Generating Facilities that plan to retire or reduce the Generating Facilities' output capability must notify PJM in order to address capacity credit issues and any potential PJM Transmission System economic and/or reliability concerns. After a Generation Owner officially notifies PJM of retirement, through the RTEP process, PJM will identify baseline system upgrades needed to resolve any reliability problems associated with the retirement. If the Generation Owner subsequently withdraws the request for retirement, PJM may continue to plan its Transmission System to accommodate retirement of the Generating Facility. The CIRs associated with the retired or reduced plant output capability may survive for up to one year following the actual Deactivation Date pursuant to PJM Tariff VII, Subpart E, Section 326(C)(3) and Part VIII, Subpart E, Section 426 (C)(3).

Generation deactivations, depending on the date of the announced retirement to PJM, have the potential to impact study results for any New Service Request that does not have an executed final agreement. Generation retirements that are announced to PJM by the Application Deadline of a Cycle will be turned offline in base case model created for that particular Cycle. Per Tariff Part VII, Subpart E, Section 328 and Part VIII, Subpart E, Section 426, the unit will remain offline in the model until the CIRs expire (if not claimed by a New Service Request), one year after their actual deactivation date. If the CIRs do expire, the unit will be removed from the model.

If a generator is reducing their output or did not build out to the output specified in their ISA or GIA, an Agreement to Amend the ISA or GIA is necessary to reflect the reduced MFO/CIR values.

Owners of existing Merchant Transmission Facilities that plan to retire or reduce the capability of a transmission facility must notify PJM in order to address any potential PJM Transmission System economic and/or reliability concerns.

9.8 Modification of New Service Requests at Cycle Decision Points

Certain modifications to New Service Requests are allowed throughout the interconnection process at decision points in the Cycle in accordance with:

1. Tariff Part VII, Subpart D, section 309(B)(4), Subpart D, section 311(B)(4) and Subpart D, section 313(C), and
2. Tariff Part VIII, Subpart C, section 406(B)(4), Subpart C, section 408(B)(4) and Subpart C, section 410(C).

Modifications must be submitted through the PJM data entry tool prior to the end of each Decision Point. Allowable changes are summarized and described in the following table.

Project Developer or Eligible Customer may not request a modification that is not expressly allowed. To the extent the Project Developer or Eligible Customer desires a modification that is not expressly allowed, Project Developer or Eligible Customer must withdraw its New Service Request and resubmit the New Service Request with the proposed modification in a subsequent Cycle.

Type of Change	Decision Point I	Decision Point II	Decision Point III
Output Reduction	Up to 100% of MFO or Capacity	Up to 10% of MFO or Capacity	None
Fuel Change	Only removal of a fuel type from a New Service Request that involves multiple fuel types as long as it meets reduction rules	Only removal of a fuel type from a New Service Request that involves multiple fuel types as long as it meets reduction rules	None
POI	1) Move along the same segment of transmission line, as defined by the two electrical nodes located on the transmission line as modeled in the Phase I base case; or 2) Move the location of the Point of Interconnection to a different breaker position within the same substation, subject to Transmission Owner review and approval.	None	None
Site Changes	Move to adjacent parcel, only if Project Developer satisfied the requirements for Site Control for both the initial Site and proposed Site.	Move to adjacent parcel, only if Project Developer satisfied the requirements for Site Control for both the initial Site and proposed Site	None

Equipment Changes	Update any equipment data	Permissible Technological Advancement changes only	None
-------------------	---------------------------	--	------

Exhibit 30: Summary of Permitted Modifications

9.8.1 Output Reduction

Project Developer may reduce the previously requested New Service Request Maximum Facility Output and/or Capacity Interconnection Rights values, up to 100 percent of the requested amount at Decision Point I and up to 10 percent of the values studied in Phase II at Decision Point II. No changes to project output are allowed after Decision Point II.

9.8.2 Fuel Changes

The fuel type for a New Service Request may not be changed for any reason at any time, except that for New Service Requests that involve multiple fuel types. Removal of a fuel type through these reduction rules will not constitute a fuel type change.

9.8.3 Point of Interconnection Changes

The Point of Interconnection (POI) must be finalized before the close of Decision Point I. Project Developer may only move the location of the Point of Interconnection:

- 1) along the same segment of transmission line, as defined by the two electrical nodes located on the transmission line as modeled in the Phase I Base Case Data, or
- 2) to a different breaker position within the same substation, subject to Transmission Owner review and approval.

Changes to the POI must be submitted prior to close of Decision Point I. No changes to the POI are permitted after the close of Decision Point I.

Note:

If a Project Developer moves the POI along the same line segment of transmission line at Decision Point I, the following updated information must be provided with their Decision Point I data submission:

1. Updated site plan showing the previous POI location and the new location
2. Site Control for any additional land if the new POI location extends outside the boundaries of the site provided Site Control provided at the Application Phase.
3. Evidence of easements between non-contiguous parcels as noted in Section 7 of this manual.

Site Control evidence and site plan must meet all the requirements of Decision Point I.

9.8.4 Site Changes

Project Developer may specify a change to the project Site at Decision Point I and Decision Point II:

1. only if the Project Developer satisfied the requirements for Site Control for both the initial Site proposed in the New Service Request Application and the newly proposed Site; and
2. the initial Site and the proposed Site are adjacent parcels.

Such Site Control is subject to the verification procedures set forth in Tariff, Part VII, Subpart D, section 313.

No changes to the project site are allowed after Decision Point II.

Evidence of easements between non-contiguous parcels are required for Site changes. Refer to Section 7 of this Manual for details.

9.8.5 Equipment Changes

Project Developer may modify its New Service Request for updated equipment data at Decision Point I. The machine modeling data associated with the requested change must be submitted via the PJM data entry tool on the PJM website prior to close of Decision Point I. After Decision Point I, only Permissible Technological Advancement equipment changes are allowed at Decision Point II.

A Project Developer may request to modify its New Service Request to include a Permissible Technological Advancement provided that the request and the associated machine modeling data are submitted no later than the close of Decision Point II. A Permissible Technological Advancement is a technological advancement to turbines, inverters, plant supervisory controls

or other similar advancement to the technology proposed in the New Service Request that does not:

- Increase the capability of the Generating Facility;
- Represent a different fuel type; or
- Cause any material adverse impact(s) on the Transmission System with regard to:
 - Short Circuit Capability limits
 - Steady-state thermal and voltage limits
 - Dynamic system stability and response

If a proposed technological advancement is deemed a Permissible Technological Advancement, then the proposed change will not be considered a Material Modification and no additional PJM study will be required. All other proposed technological changes will not be permitted after Decision Point II.

No equipment changes or Permissible Technological Advancements will be allowed at Decision Point III.

Additional Requirements for Multi-Fuel Interconnection Request

The following requirements apply to multi-fuel requests.

1. The reduction limits at each Decision Point apply to the MW of each component fuel type.
2. CIRs cannot be transferred between fuel types. The CIR requested at the Application Phase for the individual fuel type is the maximum CIR value that would be evaluated during the study.
3. Battery storage facilities can change their hour class at Decision Point I or II in the Cycle. However, if the request becomes eligible for higher CIRs, as a result of the updated hour class, the Project Developer will need to submit an update for the incremental CIRs, in order to claim the higher CIR value.

The example below illustrates changes requested for a multi-fuel generating facility consisting of solar and battery storage units.

Description	Application Phase Submission		Requested Change	
	MFO (MW)	CIR (MW)	MFO (MW)	CIR (MW)
Solar	100	60	80	48
Battery (4Hr Class)	20	20	40	32
Total	120	80	120	80

Exhibit 31: Multi-Fuel Request Example

Below is a summary of the PJM's response to the requested changes:

1) Downsize the solar to 80MW, and increase the battery storage to 40 MW, while keeping the total MFO at 120 MW:

The reduction of the solar is acceptable (if within the Decision Point I and Decision Point II limits) but the increase in the battery MWE will not be accepted.

2) Increase the CIRs of the battery and reduce the CIRs of the solar facility while keeping the total CIRs requested at 80 MW:

The reduction of the solar CIRs is acceptable (if within the Decision Point I and Decision Point II limits) but the increase in the battery CIRs will not be accepted. CIR increases will not be permitted after the application is approved.

3) Change the battery hour class from 4-Hr to either 6-Hr, 8-Hr or 10-Hr:

This change will be permitted at Decision Point I and Decision Point II.

Additional Site Control must be provided in accordance with the MWH/acreage requirements.

9.9 Multiple Requests Behind the Same Point of Interconnection (POI)

PJM performs all studies at the Point of Interconnection (POI). Subdividing projects into separate projects behind the same POI does not avoid cost allocation requirements.

At PJM's discretion, New Service Requests in a Cycle at the same Point of Interconnection may be aggregated for the purposes of Phase I, Phase II, and Phase III System Impact Studies. The cost for any upgrades triggered by the aggregate of these projects may be split in proportion to the MFO (MW) of each individual project at the POI location.

9.10 Station Power

All electric generation facilities consume some electric energy, generally referred to as "station power" in their operations. Station power is energy used for the operation, maintenance or repair of the electric equipment on the site of a generation facility.

Station power requirements can include, for example, energy used for:

1. re-starting generators after they have been shut down for maintenance or other reasons;
2. emissions control and related monitoring equipment;
3. pumping and treating cooling water;
4. fuel handling equipment; and
5. lighting, heating and air conditioning of plant control rooms and offices.

Station Power does not include any energy:

1. used to power synchronous condensers;
2. used for pumping at a pumped storage facility;
3. used in association with restoration or black start service; or
4. that is Direct Charging Energy.

Generators may obtain station power service from a local utility under retail tariffs or service agreements. Every generator in PJM's control area remains free (consistent with FERC policy) to purchase any or all of its station power from any seller connected to the grid.

Project Developers must ensure that contracts or business arrangements for obtaining Station Power are in place well before beginning generator operations.

9.11 Interconnection Procedures for FERC Jurisdictional Facilities and Non-FERC Jurisdictional Facilities

9.11.1 Applicability

In accordance with the Tariff, a Project Developer of a generator interconnecting in the PJM region to be designated, in whole or in part, as a Capacity Resource or Energy Resource, must submit a Generation New Service Request. Consistent with Tariff Part VII, Subpart F, section 335 and Tariff Part VIII, Subpart F, section 433, in some instances, Generation Project Developer may physically connect its Generating Facility to non-jurisdictional distribution or sub-transmission facilities in order to access the electrical Point of Interconnection on the Transmission System, for the purpose of engaging in FERC-jurisdictional Wholesale Transactions. In those instances, Generation Project Developer must enter into both a:

(1) non-jurisdictional interconnection agreement with the owner or operator of the non-jurisdictional distribution or sub-transmission facilities, which governs the physical connection of the Generating Facility to those non-jurisdictional facilities; and

(2) a three-party Wholesale Market Participation Agreement ("WMPA") with PJM and the affected Transmission Owner in order to effectuate Wholesale Transactions in PJM's markets. See Tariff Part IX for the WMPA.

The Project Developer must work independently with the relevant non-FERC jurisdictional entity to obtain permission to interconnect to their system.

9.11.2 Application and Study Requirements

The Project Developer shall follow all application rules in Section 2 of this Manual. In the Application, Generation Project Developer shall indicate its intent to physically connect its Generating Facility to distribution or sub-transmission facilities that currently are not subject to FERC jurisdiction, for the purpose of injecting energy at the POI and engaging in FERC-

jurisdictional Wholesale Transactions. If the two-party interconnection agreement with the owner of the non-jurisdictional facilities has been completed, the Project Developer shall provide a copy of the agreement with the new application. If the agreement has not been completed, the Project Developer shall provide all documentation demonstrating that the Project Developer has requested or applied for interconnection through the relevant non-jurisdictional process and the status of the application.

If a generation resource that desires to be designated, in whole or in part, as a Capacity Resource or Energy Resource is proposing to interconnect to facilities that are not under FERC's jurisdiction, PJM must still complete the necessary System Impact Studies to identify and mitigate any impacts to the PJM system. The Point of Interconnection for requests to non-FERC jurisdictional entities is where the non-FERC jurisdictional entity's system connects to PJM member facilities. PJM will study the generation impacts at the Point of Interconnection for reinforcement to the PJM system.

9.11.3 Need for Two-Party Interconnection Agreement

Upon completion of the System Impact Studies, in order to proceed to the execution of a Wholesale Market Participation Agreement (WMPA), Project Developer must demonstrate that it has executed the non-jurisdictional interconnection agreement by no later than Decision Point III in the applicable Cycle. Failure to timely execute the two-party interconnection agreement with the non-FERC jurisdictional entity will result in the termination of the New Service Request and withdrawal from the Cycle. Failure to meet the milestones in the WMPA may result in termination of the WMPA. Failure to participate in the wholesale market after becoming commercially operational will result in termination of the WMPA.

If the Project Developer meets the requirement of executing the non-jurisdictional interconnection agreement no later than Decision Point III, PJM will issue a WMPA with appropriate milestones for the Project Developer to commence construction and commercial operations within reasonable time periods. The WMPA will permit the Project Developer to participate in PJM's wholesale markets after completing the non-FERC jurisdictional entity's interconnection process and commencement of generation transactions.

9.12 Behind the Meter Generation

9.12.1 BtMG Applicability

Generating resources which operate "behind the meter," in isolation from the PJM bulk power transmission system and do not participate in the PJM wholesale energy or capacity markets, need only coordinate planning, construction and/or operation with the host Transmission Owner. Manual 14D (Appendix A) describes the treatment of Behind the Meter generation, provisions for which are captured in PJM's Tariff, Part VII, Subpart E, Section 317 and Tariff, Part VIII, Subpart E, Section 415.

Behind the Meter Generation (BtMG) is a generation unit that delivers energy to load without using the Transmission System or any distribution facilities (unless the entity that owns or leases the distribution facilities has consented to such use of the distribution facilities and such consent has been demonstrated to the satisfaction of PJM); provided, however, that BtMG does not include:

1. at any time, any portion of such generating unit's capacity that is designated as a Generation Capacity Resource; or
2. in an hour, any portion of the output of such generating unit that is sold to another entity for consumption at another electrical location or into the PJM Interchange Energy Market.

Generation claimed as BtMG cannot participate in the PJM Capacity or energy market. Even if partial BtMG is proposed, the portion claimed as BtMG must always stay behind the meter unless and until the generator takes the steps required for the generation participate in the wholesale markets.

Behind the Meter Generation rules permit load serving entities in PJM to net operating Behind the Meter Generation against load in the calculation of charges for energy, capacity, transmission service, ancillary services and PJM administrative fees. This total netting approach is intended to encourage the use of Behind the Meter Generation during times of scarcity and high prices, thus increasing the opportunity for load to compete in PJM markets.

A professional engineer stamped one-line configuration must be provided to show the relationship between equipment that prevents behind the meter power flow to the system, past the Point of Interconnection meter (in the case of Non-Retail BtMG, equipment must prevent BTMG power flow onto the Transmission System). Additionally, the affected entity must be aware and have performed the necessary studies to assure adequate system capabilities and protections are in place for the receipt of the power.

9.12.2 BtMG New Service Requests

Any Behind the Meter Generation that desires to be designated, in whole or in part, as a Capacity Resource or Energy Resource must submit a New Service Request Application, a form of which is located in Tariff, Part IX, Subpart A, consistent with Tariff Part VIII, Subpart E, Section 415.

The New Service Request shall include:

- (i) the facility gross output, behind the meter load, requested Maximum Facility Output, and requested Capacity Interconnection Rights or
- (ii) the existing and requested increase in gross output, behind the meter load, Maximum Facility Output, and Capacity Interconnection Rights for a requested increase in generation capability of an existing Behind the Meter Generating Facility.

The behind the meter load is the sum of station service and auxiliary loads used to support operation of the facility and any host/process loads to be served behind the Point of Interconnection. The behind the meter load provided in the New Service Request shall be the sum of the station service and auxiliary loads and the maximum host/process loads to be served behind the point of interconnection.

Station service and auxiliary loads used to support operation of the facility should be commensurate with those experienced coincident with the most recent 15 years PJM summer peaks (i.e. under summer conditions) in accordance with Manual 21: Rules and Procedures for Determination of Generation Capability, Section 1.2.

For new host/process loads to be served behind the point of interconnection, the maximum hourly integrated host/process load is to be estimated. For existing host/process loads, the maximum hourly integrated host/process load that occurred during the most recent 36 months is to be determined.

The Maximum Facility Output requested in the New Service Request is the gross generator output less station service and auxiliary loads less the minimum host/process loads that the facility is expected to serve. Of the Maximum Facility Output, the MW of capability requested to be designated as Energy Resource and MW of capability requested to be designated as Generation Capacity Resource (i.e., Capacity Interconnection Rights) is to be provided in the New Service Request.

The Capacity Interconnection Rights requested in the New Service Request are to be determined in accordance with Manual 21: Rules and Procedures for Determination of Generation Capability, Section 1.1. The Capacity Interconnection Rights requested in the New Service Request may not be greater than the gross generator output of the facility less station service and auxiliary loads less the maximum host/process loads that the facility is expected to serve.

9.12.3 BtMG Metering

Behind the meter generation consisting of one or more generating units individually rated at ten megawatts or greater or that otherwise have been identified by PJM as requiring metering for operational security reasons must have both revenue quality metering and telemetry equipment for operational security purposes. Behind the meter generation consisting of multiple generating units that are individually rated less than ten megawatts but together total more than ten megawatts at a single site and are identified by PJM as requiring revenue quality metering and telemetry equipment may meet these metering requirements by being metered as a single unit. (Operating Agreement, Section 14.5).

If a Generating Facility is to be subdivided between separate business entities behind a single Point of Interconnection, each entity shall own its own revenue grade meter or must enter into a commercial agreement that governs disbursement from a single payment. Regardless, at least one revenue grade meter, to be defined as the meter of record, must be installed at the Point of

Interconnection. If individual revenue grade meters are installed in addition to the meter of record, they will provide each participant their percentage of the meter of record. The parties behind the Point of Interconnection are required to submit to PJM hourly MW totals by party that are equal to the total of the meter of record.

9.12.4 BtMG Effects on Market Operations

Market Buyers shall be charged for all load and associated ancillary services based on the Market Buyer's total load (net of operating Behind the Meter Generation, but not to be less than zero.) (Operating Agreement, Schedule 1)

9.12.5 Non-Retail BtMG

Non-Retail BtMG means Behind the Meter Generation that is used by municipal electric systems, electric cooperatives, or electric distribution companies to serve load. The Generation Owner in this case does not request this status. The request for Non-Retail BtMG status must come for the affected electric distribution utility, electric cooperative or municipal utility, whose transmission served load requirements are being impacted.

Non-Retail BtMG rules permit load serving entities in PJM to net operating BtMG against load in the calculation of charges for energy, capacity, transmission service, ancillary services and PJM administrative fees. This total netting approach is intended to encourage the use of BtMG during times of scarcity and high prices, thus increasing the opportunity for load to compete in PJM markets.

9.13 Demand Response

“Demand Resource” means a resource with the capability to provide a reduction in demand. An On-Site Generator used to reduce load that participates in wholesale markets as a Demand Response resource should refer to PJM Manual 11 and Manual 18 for details. A portion of a Generator that may inject power past the point of interconnection must go through the interconnection process to participate in wholesale market(s) as outlined in this manual.

9.14 Service below Generating Capability

A Project Developer may request interconnection service below the full electrical generating capability of their Generating Facility. PJM studies such requests at the level of interconnection service requested for purposes of determining Interconnection Facilities, Network Upgrades, and associated costs. However, PJM, in conjunction with the affected Transmission Owner(s), may perform additional studies at the full electrical generating capability of the Generating Facility, to ensure the safety and reliability of the system. The Project Developer shall be responsible for the costs of any required additional studies.

If, after additional studies are complete, PJM determines that additional Network Upgrades are necessary, then PJM shall:

1. specify which additional Network Upgrade costs are based on which studies; and
2. provide a detailed explanation of why the additional Network Upgrades are necessary.

Any Interconnection Facility and/or Network Upgrades costs required for safety and reliability also will be borne by the Project Developer.

In addition, the Project Developers may be subject to additional control technologies as well as requirements for testing and validation of these technologies. The requirements for the necessary control technologies and protection systems shall be outlined in Tariff, Part IX, Subpart B, Schedule K (Requirements for Interconnection Service below Full Electrical Generating Capability) of the executed, or requested to be filed unexecuted, GIA.

Section 10: Transmission Interconnection Requests - Rights and Obligations

Section 10 describes the rights and obligations of Transmission Project Developers.

10.1 Rights

As specified in the PJM Tariff and Schedule 6 of the Operating Agreement, the owners of Merchant Transmission Facilities that interconnect with the PJM Transmission System may be entitled to select from a choice of the rights below if they are created by the addition of the Merchant Transmission Facilities:

- Transmission Injection Rights (TIRs) and Transmission Withdrawal Rights (TWRs)
 - These rights are described in this manual in Attachment E
- Incremental Auction Revenue Rights (IARRs)
 - These rights are described in this manual in Attachment F
- Incremental Deliverability Rights (IDRs)
 - These rights are described in this manual in Attachment G
- Incremental Capacity Transfer Rights (ICTRs)
 - These rights are described in this manual in Attachment H

10.2 Obligations

10.2.1 Signatory to PJM Consolidated Transmission Owners Agreement

In order to obtain the rights associated with Merchant Transmission Facilities, prior to the commencement of Interconnection Service associated with such facilities; the Transmission Project Developer that interconnects or adds Merchant Transmission Facilities to the Transmission System must become and remain a signatory to the applicable PJM Consolidated Transmission Owners Agreement per the PJM Tariff.

10.2.2 Maintenance of Merchant Transmission Facilities

In the event that Transmission Provider determines in accordance with the Regional Transmission Expansion Planning Protocol of Operating Agreement, Schedule 6 that an addition or upgrade to Merchant A.C. Transmission Facilities is necessary, the owner of such Merchant A.C. Transmission Facilities shall undertake such addition or upgrade and shall operate and maintain all facilities so constructed or installed in accordance with Good Utility Practice and with applicable terms of the Operating Agreement and the Consolidated Transmission Owners Agreement, as applicable. Cost responsibility for each such addition or upgrade shall be assigned in accordance with Operating Agreement, Schedule 6. Each

Transmission Owner to whom cost responsibility for such an upgrade is assigned shall further be responsible for all costs of operating and maintaining the addition or upgrade in proportion to its respective assigned cost responsibilities.

10.2.3 Additions to or Upgrades of Merchant A.C. Transmission Facilities

In the event that PJM determines in accordance with the Regional Transmission Expansion Planning Protocol of Schedule 6 of the Operating Agreement that a future addition or upgrade to Merchant A.C. Transmission Facilities is necessary, the owner of such Merchant A.C. Transmission Facilities shall undertake such addition or upgrade and shall operate and maintain all facilities so constructed or installed in accordance with Good Utility Practice and with applicable terms of the Operating Agreement and the Consolidated Transmission Owners Agreement, as applicable. See Attachment A to PJM Manual 14B for a description of PJM cost allocation methodologies.

10.3 Technical Design Requirements

10.3.1 Reactive Power Design Criteria

Merchant D.C. Transmission Facilities and/or Controllable A.C. Merchant Transmission Facilities connecting the PJM Transmission System to another control area enables:

1. the capability to inject electrical energy into the PJM Transmission System at the defined Point(s) of Interconnection between the Merchant D.C. Transmission Facilities and/or Controllable A.C. Merchant Transmission Facilities and the PJM Transmission System and
2. the capability to withdraw electrical energy from the PJM Transmission System at that same defined Point(s) of Interconnection between the Merchant D.C. Transmission Facilities and/or Controllable Merchant A.C. Transmission Facilities and the PJM Transmission system.

This capability to inject energy at a defined Point(s) of Interconnection with the PJM Transmission System is directly comparable to the capability of Generation facilities to inject energy into the PJM Transmission System. Similarly, the capability to withdraw energy at a defined Point(s) of Interconnection with the PJM Transmission System is directly comparable to the capability of load to withdraw energy from the PJM Transmission System.

Injections and withdrawals of a significant amount of energy at various points on the PJM Transmission System affect the scheduled voltage profile necessary for reliable operation of the PJM Transmission System. The reactive power losses needed to support the power flows across the PJM Transmission System due to the injections/withdrawals at the terminals of Merchant D.C. Transmission Facilities and/or Controllable Merchant A.C. Transmission Facilities have a significant impact on the PJM Transmission System voltage profile.

The effect on the PJM Transmission System voltage profile due to such injections and withdrawals of energy at the terminals of Merchant D.C. Transmission Facilities and/or

Controllable Merchant A.C. Transmission Facilities are best mitigated by compensating for the reactive power losses and the reactive requirements of the Merchant facility near their point of occurrence. Thus, a Transmission Project Developer interconnecting Merchant D.C. Transmission Facilities and/ or Controllable A.C. Merchant Transmission Facilities shall design its Customer Facility to maintain a power factor at the Point of Interconnection of at least 0.95 leading and 0.95 lagging, when the Customer Facility is operating at any level within its approved operating range.

10.3.2 Voltage Operating Criteria

Effective and reliable operation of the electric Transmission System requires scheduling a voltage profile for the system that must be followed within a narrow bandwidth. Maintaining a voltage profile across the Transmission System requires the capability to control voltage schedules at specific points on the Transmission System by implementing adjustments to voltage schedules at those locations. The Point of Interconnection of Merchant D.C. Transmission Facilities and/or Controllable Merchant A.C. Transmission Facilities are among the locations where appropriate voltage schedules and/or reactive power schedules must be controlled as specified by PJM or the Interconnected Transmission Owner's control center (acting on behalf of or at the direction of PJM) or that is consistent with Good Utility Practice.

10.3.3 Payment for Reactive Power

Any payments to the Transmission Project Developer for reactive power shall be in accordance with Schedule 2 of the Tariff. Schedule 2 of the Tariff provides for payment for Reactive Supply and Voltage Control from Generation Sources Service. Merchant Transmission facilities are not eligible to receive payment for reactive power under the provisions of Schedule 2.

10.3.4 Construction Requirements

10.3.4.1 Cost Responsibility

The Generation Interconnection Agreement defines the obligation of the Transmission Project Developer regarding cost responsibility for any required Transmission System upgrades.

Note:

Further information on all terms and conditions to be incorporated and made part of the Generation Interconnection Agreement (GIA) may be found in Section 8 of this manual and in PJM Manual M-14-C and GIA in Tariff Part IX Subpart B.

10.3.4.2 Generation Interconnection Agreement

The construction of any Interconnection Facilities required to interconnect Merchant Transmission Facilities with the PJM Transmission System shall be performed in accordance with the Standard Terms and Conditions as specified in the GIA to be executed among the

Transmission Project Developer, PJM and the affected Interconnection Transmission Owner(s). Schedule L of the GIA outlines the applicable construction requirements.

10.3.4.3 Construction Standards

The facilities of the PJM Transmission System, while operated by PJM, are comprised of the physical facilities owned by the various Transmission Owners (“TOs”). While the facilities of the various TOs are operated by PJM as a fully integrated transmission network, the physical facilities of each individual TO are designed to the particular construction standards of that TO. While particular construction standards may vary among the various TOs, all such standards are derived from those generally accepted industry standards developed by the American National Standards Institute (ANSI), the Institute of Electrical and Electronics Engineers, Inc. (IEEE) and the National Electric Safety Code.

The TOs have selected their various construction standards to facilitate operation, maintenance and repair or replacement of the various components utilized on their portion of the overall PJM Transmission System. Thus, it is essential that any additions, upgrades or other changes to the transmission facilities of any particular TO must be designed and installed to the construction standards of that TO. PJM, as the Transmission Provider, will ensure that any Constructing Entities authorized to perform construction activities under the Option to Build provisions of the PJM Tariff to interconnect with the facilities of an TO or to install or upgrade facilities within the transmission system of an TO has access to the established construction standards of that TO. All such construction standards shall be referenced in an appendix to the GIA. PJM will also ensure that the Transmission Project Developer has access to the applicable technical requirements of the TO for parallel operation with the TO’s system and other matters generally included in Good Utility Practice. PJM posts documents containing Applicable Technical Requirements and Standards for each Transmission Owner on its website.

Note:

Further information about Construction Standards and Technical Requirements applicable to Transmission Interconnection Requests may be found in PJM Manual M-14-C, Section 4.

10.3.4.4 Option to Build

The Transmission Project Developer shall have the option to assume the responsibility for the design, procurement and construction of Transmission Owner Interconnection Facilities that are Stand Alone Network Upgrades (“Option to Build”).

Note:

Further information on all terms and conditions to be incorporated under the Option to Build provision may be found in the GIA Schedule L.

10.3.5 Project Controls

PJM believes that the effective use of project controls is essential to maintaining and monitoring cost and schedules during the construction phase of Merchant Transmission Facilities.

Thus, PJM has established project controls, concepts and tools to facilitate coordination of interconnection construction activities.

Note:

Further information about interconnection coordination project controls may be found in PJM Manual M-14C.

10.3.6 Operation across Control Area Boundaries

Operations of Transmission Facilities that span from one Control Area to another control area require installation of interchange metering points. For additional details regarding operations that span Control Areas, see PJM Manual M-01 and PJM Manual M-03.

10.3.7 Operational and Maintenance Requirements

Each Interconnected Entity shall operate and maintain, or shall cause the operation and maintenance of, its facilities in a safe and reliable manner in accord with

1. the terms of the PJM Tariff
2. Applicable Standards;
3. applicable rules, procedures and protocols set forth in the Tariff and the Operating Agreement, as any or all may be amended from time to time;
4. Applicable laws and Regulations, and
5. Good Utility Practice.

10.3.8 Metering and Communication

All Merchant Transmission Facilities must install metering and communication equipment as outlined in PJM Manual 01.

Section 11: Upgrade Request

Section 11 provides an overview of Upgrade projects, including requirements for the Upgrade Request Process, and agreements applicable to Upgrade Customers

11.1 Overview

An Upgrade Customer proposes to:

- (1) fully fund new Network Upgrades to obtain financial rights called Incremental Auction Revenue Rights (IARRs) as specified in Operating Agreement Schedule 1, section 7.8
- (2) constructing Merchant Network Upgrades that either upgrade facilities or advance existing Network Upgrades

These Upgrade Customers must submit an Upgrade Request following the process summarized in this section and detailed in Tariff, Part VII Subpart H, section 337 and Part VIII Subpart H, section 435.

PJM will use Reasonable Efforts to process an Upgrade Request within 15 months of receiving a valid Upgrade Request. However, If PJM is unable to do so, PJM will notify the Upgrade Customer by posting on PJM's website a revised estimated completion date and an explanation of the reason for the delay.

At the conclusion of the Upgrade Process, the Upgrade Customer will enter into an Upgrade Construction Service Agreement.

11.1.1 Study Deposits Refunds

Upgrade Customers must submit, by wire transfer, a \$150,000 Study Deposit together with a completed and fully executed Upgrade Request. Ten (10) percent of the Study Deposit is non-refundable. Upgrade Customers are responsible for actual study costs, which may exceed the Study Deposit amount. PJM will notify the Upgrade Customer if actual costs exceed the deposit provided and request additional funds. The Upgrade Customer must: (i) provide the additional funds within 20 days of receiving the notice or (ii) withdraw its Upgrade Request; otherwise the Upgrade Request will be terminated or withdrawn.

Any remaining Study Deposit after the System Impact Study is completed will be used to pay and any outstanding monies owed by Upgrade Customer in connection with outstanding invoices related to the present or prior Upgrade Requests or other New Service Requests have been paid, and then be either:

1. Applied to the Facilities Study, if the Upgrade Customer is proceeding with the Upgrade Process

2. Returned to the Upgrade Customer at the conclusion of the required studies for the Upgrade Request, less the actual study costs incurred, if Upgrade Customer decides to withdraw its Upgrade Request

11.1.2 Readiness Deposits Refunds

Readiness Deposit refunds will be handled as follows:

1. If the Upgrade Request is withdrawn or terminated after the Readiness Deposit has been provided, the Readiness Deposit refund amount will be determined by point at which the Upgrade Request was withdrawn or terminated, and the need for any additional subsequent restudies as a result of the withdraw or termination.
2. If the project proceeds to a final Upgrade Construction Service Agreement (a form of which is located in Tariff, Part IX, Subpart E), the Readiness Deposit will be refunded upon Upgrade Customer fully executing such agreement.

Study Deposits and Readiness Deposits are non-transferrable. Under no circumstances may refundable or non-refundable Study Deposit or Readiness Deposit monies for a specific Upgrade Request be applied in whole or in part to a different Upgrade Request, a New Service Request, or any other type of request.

11.1.3 Upgrade Request Scope

Upgrade Request scope cannot include upgrades that are already included in the Regional Transmission Expansion Plan (with the exception of advancements) or subject to an existing, fully executed interconnection related agreement, such as a Generation Interconnection Agreement, stand-alone Construction Service Agreement, Network Upgrade Cost Responsibility Agreement or Upgrade Construction Service Agreement.

11.1.4 Transfer of Upgrade Request

An Upgrade Customer cannot transfer, combine, swap or exchange all or part of an Upgrade Request with any other Upgrade Request.

11.1.5 Base Case Models

The Base Case models used in performing studies are available to Upgrade Customers in accordance with Tariff, Part VII Subpart E, section 318 and Part VIII, Subpart E, Section 416, Base Case Data.

Upgrade Customers must submit a Critical Energy Infrastructure Information (CEII) request on PJM website in order to be granted access to the models. Access to the models will be granted upon approval of the CEII request.

11.1.6 Cost Allocation

Each Upgrade Customer shall be obligated to pay for 100 percent of the costs of the minimum amount of Network Upgrades necessary to accommodate its Upgrade Request and that would not have been incurred under the Regional Transmission Expansion Plan but for such Upgrade Request, net of benefits resulting from the construction of the upgrades, such costs not to be less than zero.

The costs and benefits shall include costs and benefits such as those associated with:

1. accelerating, deferring, or eliminating the construction of Network Upgrades included in the Regional Transmission Expansion Plan either for reliability, or to relieve one or more transmission constraints and which, in the judgment of PJM, are economically justified;
2. the construction of Network Upgrades resulting from modifications to the Regional Transmission Expansion Plan to accommodate the Upgrade Request; or
3. the construction of Supplemental Projects.

Where the Upgrade Request calls for accelerating the construction of a Network Upgrade that is included in the Regional Transmission Expansion Plan and provided that the party(ies) with responsibility for the construction can accomplish such an acceleration, the Upgrade Customer shall pay all costs that would not have been incurred under the Regional Transmission Expansion Plan but for the acceleration of the construction of the upgrade.

The Responsible Customer(s) designated as described in Schedule 12 of the Tariff as having cost responsibility for the Network Upgrade shall be responsible for payment of only those costs that the Responsible Customer(s) would have incurred under the Regional Transmission Expansion Plan in the absence of the New Service Request to accelerate the construction of the Network Upgrade.

11.2 Upgrade Request Process

The diagram below provides an overview of the upgrade request process.

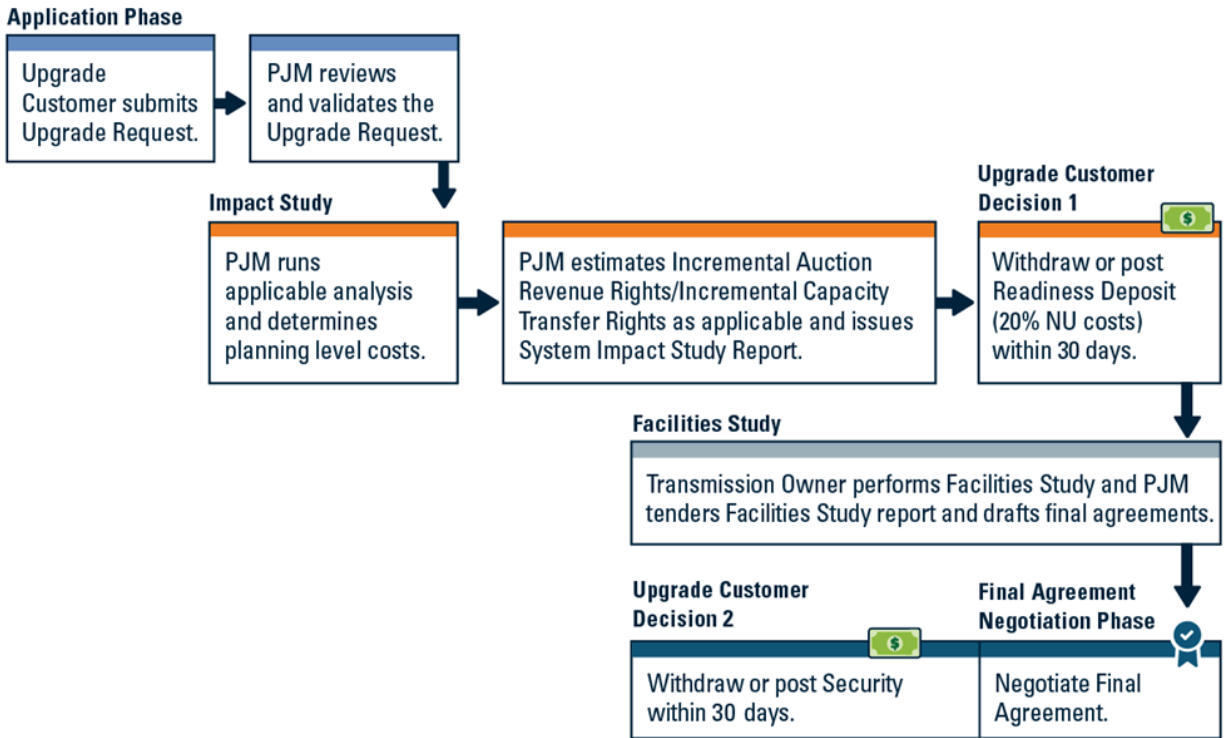

Exhibit 32: Upgrade Request Process

The Upgrade Request Process is described in further detail in the following sections.

11.2.1 Initiating an Upgrade Request

An Upgrade Customer must submit to PJM, electronically through PJM’s website, a completed and signed Upgrade Application and Studies Agreement (“Application”), a form of which is provided in Tariff, Part IX, Subpart K, including the required Study Deposit.

The data submission tool on the PJM website will guide the Upgrade Customer through the process of entering the required Application information.

PJM assigns a Request Number based upon the date and time a completed and executed Upgrade Application and Studies Agreement and deposit is received.

The Application requirements are summarized below.

11.2.1.1 Application Requirements for Incremental Auction Revenue Rights (IARR) Upgrade Requests

For PJM to consider an application for a IARR Upgrade Request complete, the Upgrade Customer must include, at a minimum, each of the following:

1. The MW amount of requested Incremental Auction Revenue Rights (IARRs), including the source and sink locations and desired commencement date, and;
2. A Study Deposit in the amount of \$150,000 (of which 10% is non-refundable)

11.2.1.2 Application Requirements for Merchant Network Upgrade Requests

For PJM to consider an application for a Merchant Network Upgrade request complete, the Upgrade Customer must include, at a minimum, each of the following:

1. the MVA or MW amount by which the normal or emergency rating of the identified facility is to be increased, together with the desired in-service date; or the Regional Transmission Expansion Plan project number and planned and requested advancement dates;
2. the substation or transmission facility or facilities where the upgrade(s) will be made;
3. (the increase in capability (in MW or MVA) of the proposed Merchant Network Upgrade;
4. if requesting Incremental Capacity Transfer Rights (ICTRs), identification of up to three Locational Deliverability Areas (LDAs) in which to determine the ICTRs;
5. the planned date the proposed Merchant Network Upgrade will be in service, such date to be no more than seven years from the date the request is received by PJM, unless the Upgrade Customer demonstrates that engineering, permitting, and construction of the Merchant Network Upgrade will take more than seven years; and
6. A Study Deposit in the amount of \$150,000 (of which 10% is non-refundable)

11.2.2 Deficiency Review

If a completed and executed Application for an Upgrade Request and Study Deposit, PJM will perform a deficiency review to establish the validity of the request as follows:

1. PJM will use Reasonable Efforts to inform Upgrade Customer of Application deficiencies within 15 Business Days after PJM's receipt of the completed Application.
2. Upgrade Customer then has 10 Business Days to respond to PJM's deficiency notice.
3. PJM will use Reasonable Efforts to review Upgrade Customer's response within 15 Business Days, and then will either validate or reject the Application.

An Upgrade Request is considered valid when PJM receives the last required agreement element, including the required deposits, from the Upgrade Customer, and the deficiency review is successfully completed.

11.2.3 System Impact Study

After receiving a valid Upgrade Request, PJM, in collaboration with the Transmission Owner, shall conduct a System Impact Study. PJM will use reasonable efforts to complete the System Impact Study within 120 days from receiving a valid Upgrade Request.

11.2.3.1 Scoping Meeting

Prior to the commencement of the System Impact Study, PJM may have a scoping meeting with the Upgrade Customer to discuss the Upgrade Request.

11.2.3.2 System Impact Study Requirements

The System Impact Study shall identify the system constraints, identified with specificity by transmission element or flowgate, relating to the Upgrade Request, and any resulting Network Upgrades or Contingent Facilities required to accommodate the Upgrade Request.

The System Impact Study shall also include:

1. The list and facility loading of all reliability criteria violations specific to the Upgrade Request.
2. Estimates of cost responsibility and construction lead times for new facilities and system upgrades.
3. The amount of incremental rights available, as applicable

11.2.3.3 Contingent Facilities

PJM identifies the Contingent Facilities in the System Impact Studies by reviewing unbuilt Network Upgrades, upon which the Upgrade Customer's cost, timing and study findings are dependent and, if delayed or not built, could cause a need for interconnection restudies of the Upgrade Request or reassessment of the unbuilt Network Upgrades.

PJM shall include the list of the Contingent Facilities in the System Impact Study(ies), including why a specific Contingent Facility was identified and how it relates to the Upgrade Request. PJM shall also provide, upon request of the Upgrade Customer, the Network Upgrade costs and estimated in-service completion time of each identified Contingent Facility, when this information is readily available and non-commercially sensitive.

The following minimum thresholds will be used to identify Contingent Facilities:

1. Load flow violations will be identified based on an impact on an overload of at least five percent distribution factor (DFAX) or contributing at least five percent of the facility rating in the applicable model.
2. Short circuit violations will be identified based on the following criteria: any contribution to an overloaded facility where the New Service Request increases the fault current impact by at least one percent or greater of the rating in the applicable model.

3. Stability and dynamic criteria violations will be identified based on any contribution to a stability violation.

11.2.3.4 System Impact Study Results

Upon completing the System Impact Study, PJM shall provide the Upgrade Customer a System Impact report on PJM's website.

11.2.3.5 Proceeding to a Facilities Study

To proceed with the Upgrade Request process, within 30 days of PJM issuing the System Impact Study report, PJM must receive from the Upgrade Customer:

1. A Readiness Deposit, by wire transfer, equal to 20 percent of the cost allocation for the Network Upgrades as calculated in the System Impact Study report.
2. If electing Option to Build, written Notification that Upgrade Customer elects to exercise the Option to Build for Stand Alone Network Upgrades identified with respect to its Upgrade Request.

Response must be provided using the PJM data submission tool.

If the 30th day does not fall on a Business Day, then the Readiness Deposit shall be due on the next Business Day thereafter.

If the Readiness Deposit is not received within 30 days, then the Upgrade Request will be terminated and withdrawn.

Upgrade Customer may not elect Option to Build after the 30 day deadline. No modifications of any type for any reason are permitted to the Upgrade Request after the 30 days following the receipt of the System Impact Study.

If (1) and (2) above are met, then PJM will proceed with the Facilities Study for the Upgrade Request.

11.2.4 Facilities Study

The Facilities Study will provide the final details regarding the type, scope and construction schedule of Network Upgrades, and any other facilities that may be required to accommodate the Upgrade Request, and will provide the Upgrade Customer with a final estimate of the Upgrade Customer's cost responsibility for the Upgrade Request.

Upon completion of the Facilities Study, PJM will provide the Facilities Study report on PJM's website, along with a draft of the UCSA.

11.2.5 Upgrade Customer Final Agreement Negotiation Phase

The Final Agreement Negotiation Phase starts on the first Business Day immediately following the tendering of the Facilities Study report. This purpose of this phase is to:

1. Negotiate, and enter into a final UCSA;
2. Conduct any remaining analyses or updated analyses; and
3. Adjust the Security obligation based on higher priority Upgrade Request(s) withdrawn during the Final Agreement Negotiation Phase.

If the 60th day does not fall on a Business Day, the phase shall be extended to end on the next Business Day. PJM shall use Reasonable Efforts to complete the Final Agreement Negotiation Phase within 60 days. If an Upgrade Request is withdrawn during the Final Agreement Negotiation Phase, PJM shall remove the Upgrade Request from the Upgrade Request process, and adjust the Security obligations of other impacted Upgrade Requests.

11.2.5.1 Final Agreement Negotiation Phase Procedures

The Final Agreement Negotiation Phase shall consist of the following terms and procedures:

1. Draft Agreement: PJM tenders an electronic draft of the Upgrade Construction Service Agreement to the parties to the agreement with the Facilities Study Report.
2. Security: Upgrade Customer must provide security within 30 days of PJM's issuance of the draft Upgrade Construction Service Agreement. If the 30th day does not fall on a Business Day, the security due date shall be extended to end on the next Business Day.
3. Negotiation: Upon receipt of the draft agreements, Upgrade Customer and Transmission Owner will have 20 Business Days to return written comments on the draft agreements.
 - a. PJM will then have 10 Business Days to respond, and if appropriate, provide revised drafts of the agreements in electronic form.
 - b. Parties may use not more than 60 days following the start of the Final Agreement Negotiation Phase to conduct negotiations concerning the draft agreements, unless PJM, at its discretion, extends the timeline.
4. Impasse: If either the Upgrade Customer, or Transmission Owner, determines that final agreement negotiations are at an impasse, that party shall notify the other parties, and may request that PJM:
 - a. File the unexecuted agreement with FERC, or
 - b. Request in writing dispute resolution as allowed under Tariff, Part I, section 12 or, if concerning the Regional Transmission Expansion Plan, consistent with Operating Agreement, Schedule 5.
 - Alternatively, if PJM determines that the negotiations are at an impasse, PJM will notify the other parties, and may file the unexecuted agreement with the FERC.

5. Execution and Filing: No later than five Business Days following the end of negotiations within the Final Agreement Negotiation Phase, PJM will tender the final Upgrade Construction Service Agreement, to the parties in electronic form.
 - a. Upgrade Customer Execution: No later than 15 Business Days after receipt of the final interconnection related agreement, Upgrade Customer shall either:
 - i. Execute the final Upgrade Construction Service Agreement in electronic form and return it to PJM electronically;
 - ii. Request in writing dispute resolution as allowed under Tariff, Part I, section 12 or, if concerning the Regional Transmission Expansion Plan, as allowed under Operating Agreement, Schedule 5; or
 - iii. Request in writing that PJM file with FERC the final interconnection related service agreement unexecuted, with the final interconnection related service agreement containing terms and conditions deemed appropriate by PJM, and provide any required adjustments to Security.
 - b. Transmission Owner Execution: If an Upgrade Customer executes the final Upgrade Construction Service Agreement, then, no later than 15 Business Days after PJM sends notification to the relevant Transmission Owner, the relevant Transmission Owner shall either:
 - i. Execute the final Upgrade Construction Service Agreement in electronic form and return it to PJM electronically;
 - ii. Request in writing dispute resolution as allowed under Tariff, Part I, section 12 or, if concerning the Regional Transmission Expansion Plan, as allowed under Operating Agreement, Schedule 5; or
 - iii. Request in writing that PJM file with FERC the final Upgrade Construction Service Agreement in unexecuted form.
 1. The unexecuted Upgrade Construction Service Agreement shall contain terms and conditions deemed appropriate by PJM for the Upgrade Request.
6. Proceeding under Agreement: Parties may not proceed under the Upgrade Construction Service Agreement until:
 - a. 30 days after such agreement, if executed and nonconforming, has been filed with the Commission;
 - b. such agreement, if unexecuted, has been filed with and accepted by the Commission; or
 - c. the earlier of 30 days after such agreement, if conforming, has been executed or has been reported in PJM's Electronic Quarterly Reports

11.2.6 Upgrade Construction Service Agreement

In the event that construction of facilities by more than one Transmission Owner is required, PJM will tender a separate Upgrade Construction Service Agreement for each such Transmission Owner and the facilities to be constructed on its transmission system.

11.2.6.1 Cost Reimbursement

Pursuant to the Upgrade Construction Service Agreement, a Upgrade Customer shall agree to reimburse PJM (for the benefit of the affected Transmission Owners) for the Costs, determined in accordance with Tariff, Part VIII, Subpart C, section 404(A)(5) of constructing Distribution Upgrades, and/or Network Upgrades necessary to accommodate its New Service Request to the extent that the Transmission Owner is responsible for building such facilities pursuant to Tariff, Part VIII and the applicable Upgrade Construction Service Agreement.

The Upgrade Construction Service Agreement shall obligate the Upgrade Customer to reimburse PJM (for the benefit of the affected Transmission Owner(s)) as the Transmission Owner's expenditures for the design, engineering, and construction of the facilities that it is responsible for building pursuant to the Upgrade Construction Service Agreement are made.

PJM shall distribute the revenues received under this Tariff, Part VIII, Subpart H, section 435 to the affected Transmission Owner(s).

11.2.6.2 Upgrade-Related Rights

The Upgrade Construction Service Agreement specifies the Upgrade-Related Rights that the Upgrade Customer is entitled as described in Tariff, Part VIII, Subpart E, sections 426, 427, 428, and 430, except to the extent the applicable terms of Tariff, Part VIII, Subpart E, sections 426, 427, 428, and 430 provide otherwise.

The applicable rights are listed below:

1. Incremental Auction Revenue Rights (IARRs): These rights are described in this manual in Attachment E.
2. Incremental Capacity Transfer Rights (ICTRs): These rights are described in this manual in Attachment H.

Note:

No Incremental Auction Revenue Rights shall be received by an Upgrade Customer with respect to transmission investment that is included in the rate base of a public utility and on which a regulated return is earned.

11.2.6.3 Specification of Transmission Owners Responsible for Facilities and Upgrades

The Facilities Study (or the System Impact Study, if a Facilities Study is not required) shall specify the Transmission Owner(s) that will be responsible, subject to the terms of the

applicable Upgrade Construction Service Agreement, for the construction of facilities and upgrades, determined in a manner consistent with Operating Agreement, Schedule 6.

11.2.7 Withdraw or Termination

1. If an Upgrade Customer decides to withdraw its Upgrade Request, PJM must receive written notification from the Upgrade Customer of Upgrade Customer's decision to withdraw its Upgrade Request.
2. PJM may deem an Upgrade Request terminated and withdrawn for failing to meet any of the applicable tariff requirements.
3. If an Upgrade Request is either withdrawn or deemed terminated and withdrawn, it will be removed from the Upgrade Request process and all relevant models, and, as applicable, the Readiness Deposits and Study Deposits will be disbursed as follows:
 - a. For Readiness Deposits: At the conclusion of PJM's Facility Study, PJM will refund to the Upgrade Customer 100 percent of Readiness Deposit paid by the Upgrade Customer.
 - b. For Study Deposits: At the point at which the Upgrade Customer requested to withdraw the Upgrade Request or PJM terminated the Upgrade Request, PJM will initiate the process to refund to the Upgrade Customer up to 90 percent of its Study Deposit submitted with its Upgrade Request during the Application less any actual costs for studies conducted up to and including the point of withdraw or termination of the Upgrade Request.

11.2.8 PJM Website Postings

PJM will maintain a list of Upgrade Requests on the PJM's website in accordance with the Tariff.

Section 12: Surplus Interconnection Service

Section 12 outlines the procedures for administering the Surplus Interconnection Service. Additional requirements are found in Tariff Part VIII, Subpart E, section 414.

12.1 Overview of Surplus Interconnection Service

Surplus Interconnection Service refers to any unneeded portion of the Interconnection Service established in an Interconnection Service Agreement ("ISA") or Generation Interconnection Agreement ("GIA"), such that if the service is used, the total amount of Interconnection Service at the Point of Interconnection ("POI") would remain the same.

Surplus Interconnection Service requests can be made by a Project Developer or one of its affiliates whose Generating Facility is already interconnected to the PJM Transmission System or has executed (or requested to file unexecuted) an ISA or GIA, or by an unaffiliated Project Developer. The Project Developer or one of its affiliates has priority to use this service; however, if they do not exercise this priority, the unaffiliated Project Developer may also request Surplus Interconnection Service.

Surplus Interconnection Service is limited to utilizing or transferring a Generating Facility's Surplus Interconnection Service at the POI established in the ISA or GIA. Surplus Interconnection Service shall not exceed the total amount of Interconnection Service stated in the ISA or GIA, i.e., the total amount of Interconnection Service between the Generating Facility and the generating facility requesting Surplus Interconnection Service shall not exceed the lesser of the Maximum Facility Output ("MFO") stated in the ISA or GIA, or the total "as-built capability" of the Generating Facility.

If Surplus Interconnection Service is requested on a Generating Facility that is an Energy Resource, the generating facility requesting the Surplus Interconnection Service shall be an Energy Resource. If Surplus Interconnection Service is requested on a Generating Facility that is a Capacity Resource, the generating facility requesting Surplus Interconnection Service may be an Energy Resource or a Capacity Resource (not to exceed the amount of Capacity Interconnection Rights ("CIRs") established in the ISA or GIA).

12.1.1 Surplus Interconnection Service Request Example

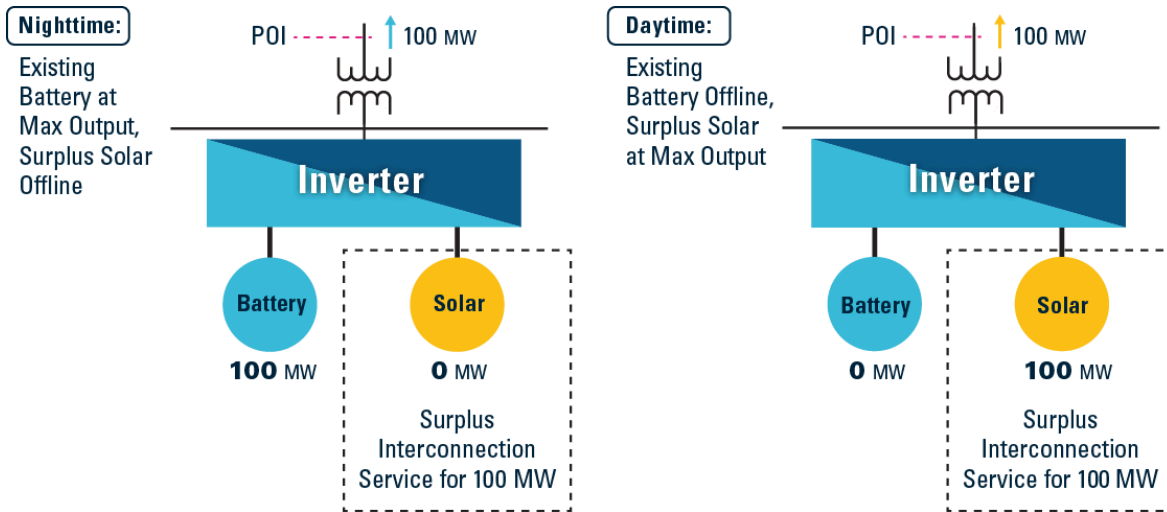

Exhibit 33: Surplus Interconnection Service Example

In the Exhibit above, a 100 MW solar facility is utilizing Surplus Interconnection Service on a 100 MW battery storage facility. The battery storage facility operates at night only, while the solar facility operates during the day when the battery storage facility's output is negligible. However, the net output at the POI never exceeds the 100 MW MFO captured in the GIA.

During night time operations, illustrated by the diagram on the left, the battery storage facility is online and the output is 100 MW, while the solar facility is offline. The net output at the POI is 100 MW. During day time operations, illustrated by the diagram on the right, the battery storage facility is offline, while the solar facility is online at its maximum output, 100 MW. The net output at the POI is still 100 MW.

In order for a Surplus Interconnection Request to be approved, there must be no new Network Upgrades required to accommodate the request, including no additional scope for planned Network Upgrades. Additional Interconnection Facilities that are necessary to accommodate the request are permitted.

12.2 Surplus Interconnection Request Process

The Surplus Interconnection Request process is summarized in the process flow diagram below and discussed in the following sub-sections.

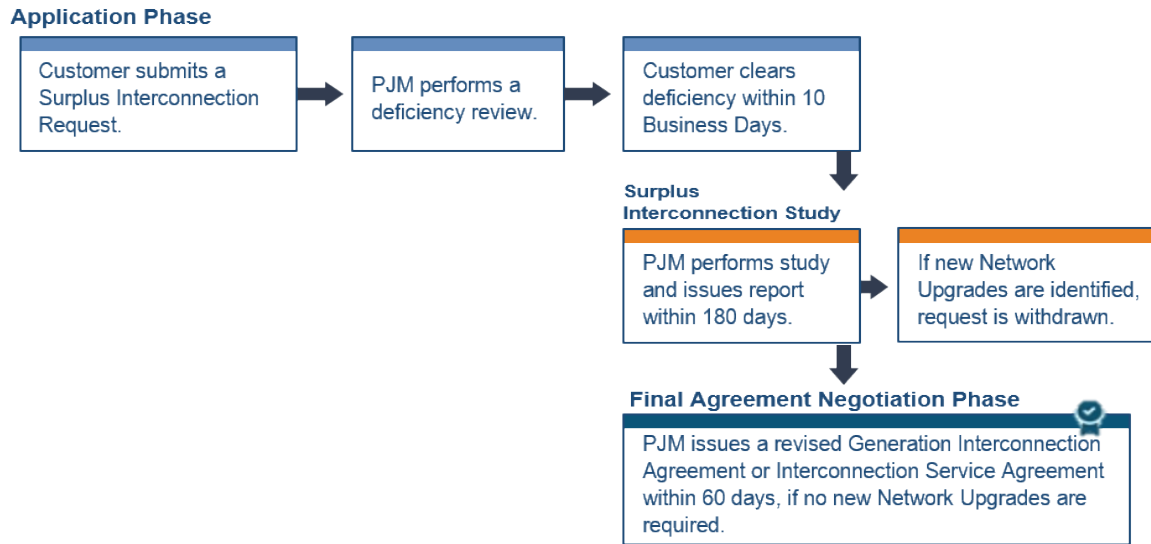

Exhibit 34: Surplus Interconnection Request Process

12.2.1 Initiating a Surplus Interconnection Request

In order to initiate a Surplus Interconnection Request, the Surplus Project Developer must complete and execute the Surplus Interconnection Study Agreement located in Tariff, Part IX, Subpart I, and provide the required data via the PJM data submission tool.

The PJM data submission tool allows customers to enter data, which is used to conduct various studies in order to determine if the Surplus Interconnection Service request meets the eligibility criteria. The tool is available on the PJM Website along with a user guide.

12.2.2 Surplus Interconnection Study Agreement Requirements

In order to have a complete Surplus Interconnection Request, the submission shall include a complete and executed Surplus Interconnection Study Agreement, the appropriate deposit, and, at minimum, the information listed below:

1. Identification of the Generating Facility that is subject to an ISA or GIA. The ISA or GIA must be fully executed, or filed unexecuted, prior to submitting the Surplus Interconnection Request. An existing Generating Facility that does not have an active ISA or GIA should follow the Non-Cycle Process outlined in Section 14: Converting a Two-Party Agreement to a GIA;
2. A description of the project location including street address and global positioning coordinates;
3. A map depicting the property boundaries and the proposed surplus generating facility's location(s);

4. The megawatt capability of the proposed surplus generating facility or the amount of increase in capability of an existing surplus generating facility
5. Fuel type(s) of the surplus generating facility;
6. One line diagram showing the proposed equipment configuration;
7. Data as required to complete the study as required in Queue Point. Dynamic data must be provided in accordance with the latest Dynamic Model Development Guidelines posted on PJM.com;
8. Primary frequency response operating range for the surplus generating facility (for Energy Storage facilities only);
9. Proof of right to control the site for the proposed project for a minimum of three years. Refer to Section 7 of this manual for additional Site Control requirements;
10. Anticipated in-service date;
11. A description of the circumstances under which Surplus Interconnection Service will be available at the Generating Facility's POI;
12. Required deposit (\$10,000 plus \$100 per MW, not to exceed \$110,000). Any unused portion of the refundable deposit will be returned to the Surplus Project Developer, if the request is withdrawn, terminated, or upon completion of the surplus interconnection process;
13. Identification of the Generating Facility providing Surplus Interconnection Service, including documentation of the relationship between the Surplus Project Developer and the Generating Facility owner; and
 - a. If the Surplus Project Developer is not the same entity as the owner of the Generating Facility, the following must be provided:
 - i. Written permission from the owner of the Generating Facility to use the unused portion of the Interconnection Service established in the ISA or GIA; and
 - ii. Written documentation stating that the owner of the surplus generating facility and the owner of the Generating Facility will have entered into a shared facilities agreement detailing their respective roles and responsibilities relative to the Surplus Interconnection Service prior to the owner of the Generating Facility executing a revised ISA or GIA.
14. Any additional information prescribed by PJM.

A Surplus Interconnection Request Number is assigned once all the requisite information and deposit is provided to PJM.

12.2.3 Surplus Interconnection Request Deficiency Review

Surplus Interconnection Request validity is determined by a deficiency review. If the Surplus Interconnection Request is missing information, is deficient, or if the Surplus Project Developer owes money from prior New Service Requests, PJM will issue a deficiency notification to the Surplus Project Developer.

Upon PJM issuing the deficiency notification, the Surplus Project Developer has 10 Business Days to provide the missing/deficient information and/or money. If the Surplus Project Developer does not clear all identified deficiencies within 10 Business Days, the Surplus Interconnection Request shall be terminated and withdrawn.

The Surplus Interconnection Request shall be considered valid as of the date and time PJM receives from the Surplus Project Developer, the last piece of required information and/or monies deemed acceptable by PJM to clear such deficiency notice.

12.2.4 Surplus Interconnection Study

After PJM determines it has received a valid Surplus Interconnection Request, PJM, in collaboration with the Transmission Owner, conducts a surplus interconnection study. Prior to the commencement of the study, PJM may have a scoping meeting with the Surplus Project Developer to discuss the Surplus Interconnection Request.

The surplus interconnection study scope consists of reactive power, short circuit/ fault duty, stability, steady-state (thermal/voltage) analyses, and any other studies deemed appropriate by PJM. The scope of the studies and the study criteria used for Surplus Interconnection Requests is consistent with that used in the Cycle Phase I, Phase II, and Phase III System Impact Studies, as described in M14H sections 4.3, 4.5, and 4.7.

PJM will study the Surplus Interconnection Request on the latest Phase III study model for the Cycle which has most recently started Phase III. This applies to all study models (Load Flow, Short Circuit and Stability).

Contingent Facilities, if any, would be identified during the Surplus Interconnection Study in the same manner they are identified in the Cycle Phase I, Phase II, and Phase III System Impact Studies (see M14H sections 4.2.3 and 4.2.3.1) and will be listed in the revised ISA or GIA.

PJM will use Reasonable Efforts to complete the study within one hundred and eighty (180) days of determination of a valid Surplus Interconnection Request. In the event that PJM is unable to complete the study in the specified timeframe, PJM will notify the Surplus Project Developer of the estimated completion date and the reason why additional time is required.

Upon completion of the surplus interconnection study, PJM will issue the surplus interconnection study report to the Surplus Project Developer. If the Surplus Project Developer is an unaffiliated third party, PJM will issue the surplus interconnection study report to the owner of the Generation Facility.

12.2.5 Agreement for Surplus Interconnection Requests

If the surplus interconnection study results indicate that all the criteria for Surplus Interconnection Service have been met, PJM will issue a revised ISA or GIA to the owner of the Generating Facility, within 60 days of issuing the surplus interconnection service report. However, if the study results indicate all the criteria have not been met, then the Surplus

Interconnection Request will be terminated and withdrawn upon issuing the surplus interconnection study report.

Within 60 days of receipt of the revised ISA or GIA , the owner of the Generating Facility will either:

1. Execute the revised ISA or GIA,
2. Request dispute resolution, or
3. Request that the revised ISA or GIA be filed unexecuted in accordance with the Tariff.

Failure to take one of the actions above will result in termination and withdrawal of the Surplus Interconnection Request.

12.3 Deactivation of Existing Generating Facility Providing Surplus Interconnection Service

Surplus Interconnection Service cannot be offered if the Generating Facility providing Surplus Interconnection Service deactivates or submits a notice to deactivate prior to the commercial operation of the surplus generating facility. However, an in-service surplus generating facility may continue limited operation for up to one year after the deactivation of the Generating Facility if:

1. PJM has studied the surplus generating facility for sole operation at the Point of Interconnection, and
2. the owner of the Generating Facility provides written consent for the Surplus Project Developer to operate at or below the surplus generating facility's share of the Generating Facility's capability.

If the Surplus Project Developer is unable to satisfy the conditions above, the revised ISA or GIA for the Generating Facility will be terminated.

Section 13: Affected System Studies

Section 13 provides an overview of procedures for coordinating Affected System Studies for cases where the Affected System is an Electric System other than the PJM Transmission System, as well as where PJM's Transmission System is the Affected System.

13.1 Introduction

PJM coordinates Affected System Studies with the neighboring Affected System Operators to determine:

1. Impacts of PJM New Service Requests on the Affected System Operators Transmission System, and
2. Impacts of projects interconnecting to the Affected System Operators Transmission System on the PJM System.

The neighboring Affected System Operators include:

- MISO
- NYISO
- Duke Energy Progress
- Duke Energy Carolinas
- TVA
- LGE-KU

Tariff, Part VII Subpart G, section 336 and Part VIII Subpart G, section 434 outline the Affected System Rules. However, additional Affected System rules and procedures are outlined in the applicable Affected System Operator's Joint Operating Agreement or Joint Reliability Coordination Agreement with PJM.

The following definitions used in the PJM Tariff will also apply in this section:

1. "Affected System" is an electric system other than the Transmission Provider's Transmission System that may be affected by a proposed interconnection or on which a proposed interconnection or addition of facilities or upgrades may require modifications or upgrades to the Transmission System.
2. "Affected System Customer" is the developer responsible for an Affected System Facility that requires Network Upgrades to Transmission Provider's Transmission System.
3. "Affected System Operator" is the entity that operates an Affected System or, if the Affected System is under the operational control of an independent system operator or a regional transmission organization, such independent entity.

4. “Affected System Customer Facility Study Agreement” shall mean the agreement set forth in Tariff, Part IX, Subpart N.

13.2 Affected System Rules Where Affected System is an Electric System Other than PJM

13.2.1 Overview

If a PJM New Service Request impacts an Affected System, PJM will notify the impacted Affected System Operator. PJM, at its discretion, will involve the Affected System Operator to participate in meetings held with the Project Developers or Eligible Customers.

The Project Developers and Eligible Customers whose projects impact the Affected System must also cooperate with PJM and the Affected System Operator to conduct any studies to determine the required modifications to Affected Systems.

The Project Developer or Eligible Customer is responsible for arranging any necessary engineering, permitting, and/or construction of distribution on the Affected System or for obtaining any regulatory approval for the facilities. However, PJM and the impacted PJM Transmission Owners will use Reasonable Efforts to support the activities of the Project Developer and Eligible customer in making these arrangements.

For example, if an Affected System Operator requires an agreement with the PJM Project Developer or Eligible Customer, in order to initiate any Affected System Studies, PJM will notify the PJM Project Developer or Eligible Customer of the need to do so. However, it is the responsibility of the Project Developer or Eligible Customer to enter into and execute any agreements required by an Affected System Operator within the timeframes specified in the Tariff.

If available, PJM will provide Affected System Study results to Project Developers or Eligible Customers in Phase II of the relevant Cycle.

The Project Developer or Eligible Customer will be responsible for the costs on any upgrades to address the impacts to the Affected System. The cost allocation for these upgrades will be in accordance with the Affected System Operator’s Tariff, only if their project request was initiated in the Affected System Operator’s tariff.

If any required Affected System upgrades have not been completed, prior to the commencement of the operations of the Generating Facility or Merchant Transmission Facility (Initial Operation), PJM at its discretion may limit service of the project’s facilities, in accordance with Good Utility Practice, until any interim deliverability analysis by the Affected System Operator are completed.

13.2.2 Affected System Coordination Process

The diagram below provides an overview of the Affected System Coordination Process.

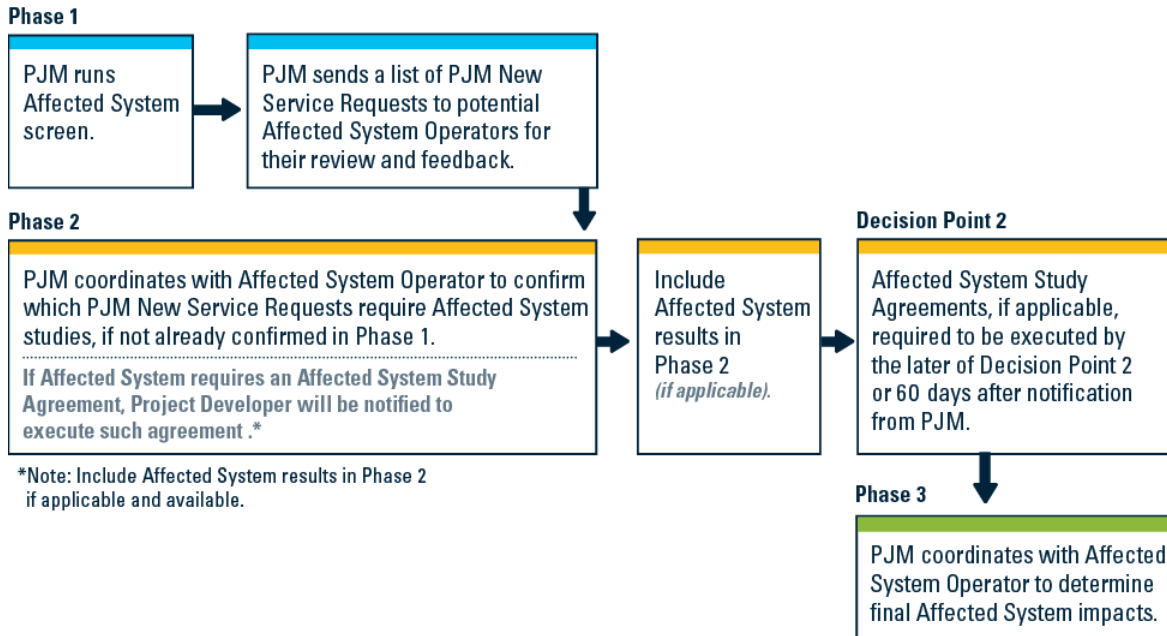

Exhibit 35: Affected System Study Process

The procedure is summarized below:

1. In Phase I of the Cycle, PJM conducts an Affected System screen to identify any New Service Request with potential Affected System impacts. PJM initiates coordination with each Affected System Operator by providing a list of New Service Requests in the Cycle with potential impacts to their respective system.
2. In Phase II of the Cycle, PJM continues to coordinate with the Affected Systems to confirm which projects in the PJM Cycle will require Affected System studies, if not already confirmed by the Affected System in Phase I.
3. If the Affected System Operator indicates that an Affected System study is required, PJM will:
 - a. Notify the Project Developer or Eligible Customer of the need for an Affected System study and, if applicable, the requirement to execute an Affected System study agreement with the impacted Affected System Operator; and
 - b. Include the results of the Affected System Operator's Affected System Study in the Phase II System Impact Study results, if applicable and available.

4. If an Affected System study agreement is required by the Affected System Operator, in order to remain in the relevant Cycle, the Project Developer or Eligible Customer must enter into an affected system study agreement with the Affected System Operator by the later of:
 - a. The conclusion of Decision Point II of the relevant Cycle, or
 - b. 60 days of PJM sending notification to Project Developer or Eligible Customer of the need to enter into such Affected System Study Agreement.
5. PJM will coordinate with Affected System Operators to conduct any studies required to determine the final impact of a New Service Request on any Affected System and will include the final Affected System Study with those results in the Phase III System Impact Study, if available from the Affected System.
6. Project Developer or Eligible Customer will cooperate with the PJM in all matters related to the conduct of studies by Affected System Operators and the determination of modifications to Affected Systems needed to accommodate the New Service Request. If Affected System impacts and system upgrades are identified and required on an Affected System, the PJM Project Developer or Eligible Customer shall enter into the appropriate Facilities Study agreement as required under the Affected System Operator's Tariff.
7. Requirements for construction of such Affected System Network Upgrades will be under the terms of the applicable Affected System Operator's Tariff.
8. In accordance with the applicable Joint Operating Agreement and Affected Systems Operator's Tariff, the Affected System Operator may determine any necessary injection limits associated with PJM New Service Request that should be implemented in Real Time until the necessary Affected System upgrades, identified through the affected system study, are placed in-service.

13.3 Affected System Rules Where PJM's Transmission System is the Affected System.

13.3.1 Coordination with System Where Interconnection Was Initiated

- After receiving a notification from the system where interconnection was initiated that a proposed Interconnection Request or long term firm transmission service request may impact PJM's system, PJM will review and determine whether an affected system study will be required to determine potential impacts to PJM transmission system.
- If required, PJM will notify the system where interconnection was initiated that an affected system study will be required to determine impacts to PJM transmission system and request any additional necessary modeling details and data from the system where interconnection was initiated in order to perform the affected system study.
- PJM will perform an affected system study to determine impacts to PJM transmission system.

- PJM will communicate the results of the affected system study to the system where interconnection was initiated.
- If impacts and system upgrades are identified and required to PJM transmission system, the Affected System Customer shall enter into an Affected System Customer Facility Study Agreement with PJM. It is the responsibility of the Affected System Customer to initiate this request with PJM.
- In the event that Network Upgrades are required on the PJM system, then service will commence on a schedule mutually agreed upon among the parties. This schedule will include milestones with respect to the Network Upgrade construction and the amount of service that can commence after each milestone.
- PJM will determine any necessary limits associated with the Interconnection Request or long-term firm transmission service request that should be implemented in Real Time until the necessary PJM system upgrades identified through PJM’s affected system analysis are placed in-service.

13.3.2 Affected System Customer Facilities Study Process

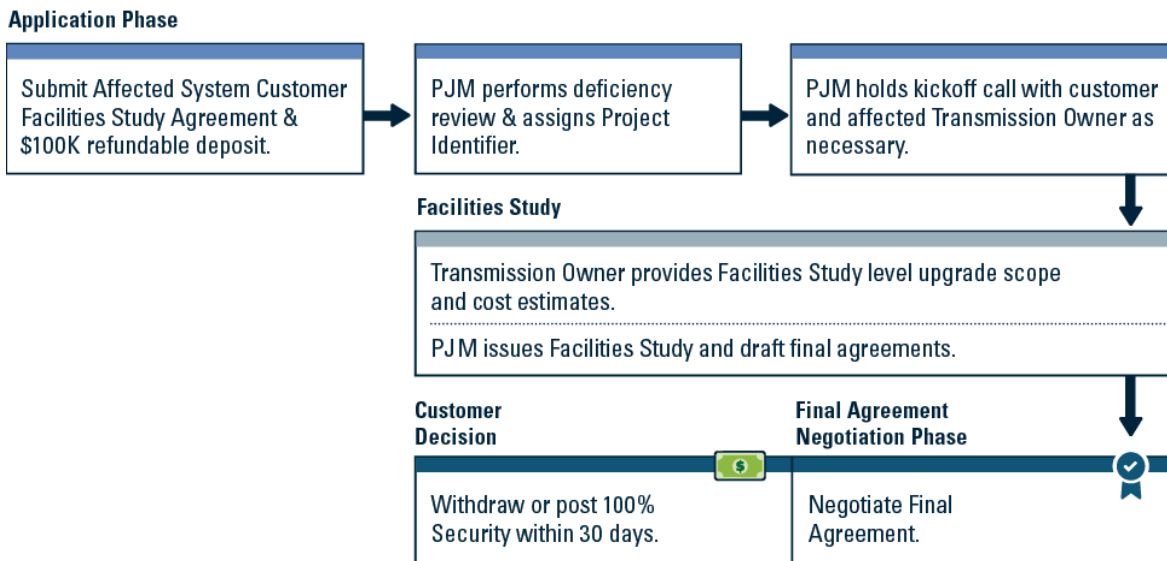

Exhibit 36: Affected System Facilities Study Process

The diagram above provides an overview of the Affected System Customer Facilities Study process described in this section.

13.3.2.1 Application Submission

An Affected System Customer responsible for an Affected System Facility that requires Network Upgrades to PJM’s Transmission System must contact PJM via the Customer Service email on

the PJM website to initiate the request. Upon contact by the Affected System Customer, PJM will provide the Affected System Customer an Affected System Customer Facility Study Agreement. The Affected System Customer must electronically submit and execute an Affected System Customer Facility Study Agreement and provide the required \$100,000 Study Deposit, by wire transfer.

The Affected System Customer must include the project identifier or reference number assigned to the Affected System Facility by the Affected System Operator in wire details and provide to PJM the relevant Affected System Operator Study that identified the need for a Facilities Study Agreement.

PJM will use the same project identification or reference number used by the Affected System Customer's Affected System Operator to identify the Affected System Facilities Study request.

Note:

The Affected System Customer is responsible for all actual study costs. If additional deposits are required, PJM will notify the Affected System Customer and then Affected System Customer must either (1) provide the additional deposit within 20 Business Days or (2) withdraw its request. If the Affected System Customer does not comply with (1) and (2), then their request will be terminated and withdrawn.

13.3.2.2 Application Review

After PJM confirms the submission of a Complete Application, PJM will use Reasonable Efforts to conduct a deficiency review and notify the Affected System Customer of any deficiencies in their Agreement. PJM will start the Affected System Facilities Study only after all deficiencies have been addressed by the Affected System Customer and an updated executed Affected System Customer Facilities Study Agreement has been submitted by the Affected System Customer.

PJM will execute this agreement after the Affected System Customer, and will subsequently initiate the Facilities Study with the impacted PJM Transmission Owner(s).

13.3.2.3 Affected System Facilities Study

After the Affected System Customer Facilities Study Agreement is fully executed, PJM may hold a Facilities Study kickoff meeting with the Affected System Customer and the relevant PJM Transmission Owner(s), and at its discretion invite the Affected System Operator to the meeting.

PJM will coordinate with the Affected System Operator to conduct the Facilities Study. The Affected System Facilities Study will provide the scope, cost and schedule for construction of any required upgrades to the PJM Transmission Owner(s) System.

PJM will issue a Facilities Study Report to the Affected System Customer at the conclusion of the study, accompanied by a draft of the relevant final agreements.

13.3.2.4 Final Agreement Negotiation:

The Final Agreement Negotiation Phase starts on the first Business Day after the Affected System Facilities Study is tendered. PJM will use Reasonable Efforts to conclude the negotiation within 60 days in accordance with Tariff Part VII, Subpart G, section 336(3) and Part VIII, Subpart G, section 434(3).

Draft Agreement:

PJM will issue the Facilities Study report to the Affected System Customer accompanied by an electronic draft of the applicable final agreement(s). In this case, the final agreements are:

1. a stand-alone Construction Service Agreement and
2. a Network Upgrade Cost Responsibility Agreement, as applicable

The developer of the Affected System Facility will be referred to as a “Project Developer” in these agreements and the terms applicable to “Project Developer” in the agreements will apply. Additional information on final agreements are available in Section 5 of this manual and in Tariff Part IX.

Security:

Within 30 days of receiving the draft final agreements, the Affected System Customer must provide the required security amount as set forth in the agreement.

The security obligation may be adjusted if the withdrawal of New Service Requests in a Cycle or Upgrade Requests in the Upgrade Process impact the initially calculated security.

Negotiations:

After the draft agreements are tendered, Affected System Customer and Transmission Owner(s), as applicable, will have 20 Business Days to return written comments on the draft agreement(s).

Then PJM will have 10 Business Days to respond and, if appropriate, provide revised draft(s) of the agreement(s) in electronic form.

Although the Parties may use not more than 60 days to conduct negotiations on the draft agreements, PJM, in its sole discretion, may extend the Final Agreement Stage beyond 60 days.

Impasse:

If either the Affected System Customer or Transmission Owner determine that final agreement negotiations are at an impasse, they must notify the other parties, and may request:

PJM to file the unexecuted Construction Service Agreement or a Network Upgrade Cost Responsibility Agreement with FERC or

1. Request in writing dispute resolution in accordance with the Tariff.
2. However, if PJM determines that the negotiations are at an impasse, PJM will notify the other parties of the impasse, and may file the unexecuted agreement with the FERC.

Affected System Customer Execution:

Within 15 Business Days after receipt of the final agreements, the Affected System Customer shall either:

1. execute the final Construction Service Agreement or Network Upgrade Cost Responsibility Agreement and return it to PJM electronically;
2. request in writing dispute resolution in accordance with the Tariff; or
3. request in writing that PJM file the agreement(s) unexecuted with FERC, and
4. provide any required adjustments to the security.

Transmission Owner Execution:

After the Affected System Customer executes the final agreement, then, not later than 15 Business Days after PJM notifies the Transmission Owner, the relevant Transmission Owner will:

1. execute the final agreement and return it to PJM electronically;
2. request in writing dispute resolution in accordance with the Tariff; or
3. request in writing that PJM file the agreement(s) unexecuted with FERC

PJM Execution:

After the Affected System Customer and Transmission Owner have executed the final agreements, PJM will execute the agreement and file the agreement with FERC in accordance with the Tariff.

Proceeding under the Agreement:

Parties may not proceed under the Construction Service Agreement or a Network Upgrade Cost Responsibility Agreement until:

- (i) 30 days after the agreement, if executed and nonconforming, has been filed with FERC;
- (ii) the agreement, if unexecuted, has been filed with and accepted by the Commission; or
- (iii) the earlier of 30 days after the agreement, if conforming, has been executed or has been reported in PJM's Electronic Quarterly Reports.

Section 14: Converting a Two-Party Agreement to a GIA

Section 14 describes the process whereby existing generators already interconnected to PJM that are currently operating under a two-party Interconnection Agreement, a power purchase agreement, or both, may convert to a PJM three-party GIA.

14.1 Overview

PJM's Cycle process for generation interconnection applies to all new generation and updates to existing generators. For existing generators already interconnected to PJM that are currently operating under a two-party Interconnection Agreement, a power purchase agreement, or both, and seek to convert to a PJM three-party GIA due to a transfer of ownership or the underlying agreement is reaching term, a New Service Request is not required. If the generator is seeking to uprate facilities coincident with entering into a three-party GIA, a New Service Request will be required and this section is not applicable.

For purposes of tracking the project, identifying the generator in PJM's processes and in FERC filings, and ensuring all costs associated with the conversion are paid by the Project Developer, PJM developed an agreement and procedures to accomplish the request, referred to as the "Non-Cycle Process."

In general, a two-party interconnection agreement or power purchase agreement will likely be converted directly to a GIA. However, it is possible that an interconnection arrangement historically permitted may have provisions unacceptable under the Tariff. The following are examples:

1. A generator's Interconnection Facilities arrangement does not conform to PJM's Tariff and requires rearrangement of the Interconnection Facilities; or
2. Existing metering does not meet PJM requirements, metering modifications may be required.

The list above is not exhaustive nor do the examples portray all potential scenarios and issues that may need to be addressed during the non-Cycle GIA process; rather, it demonstrates that in addition to drafting a GIA, a Construction Service Agreement (CSA) may be required.

Note:

Attorney review and filing durations must be considered by the Project Developer when requesting PJM to implement these three-party agreements. If the legacy agreements contain terms and conditions not normally captured by the GIA, time for negotiations may also be required. Because of this potential negotiation period, PJM requests a minimum of a six month notice prior to the termination of a underlying agreement or an ownership change, which requires conversion to a three-party GIA.

PJM has developed a Cost Responsibility Agreement (CRA) to cover PJM and Transmission Owner costs associated with the GIA development. A deposit of \$10,000 is required with the CRA and any unspent money associated with the deposit is refundable once the GIA is executed or if the Project Developer changes their mind regarding receiving the GIA. The CRA must be filed with the FERC.

14.2 Procedure to Convert a Two-Party Interconnection Agreement to a GIA

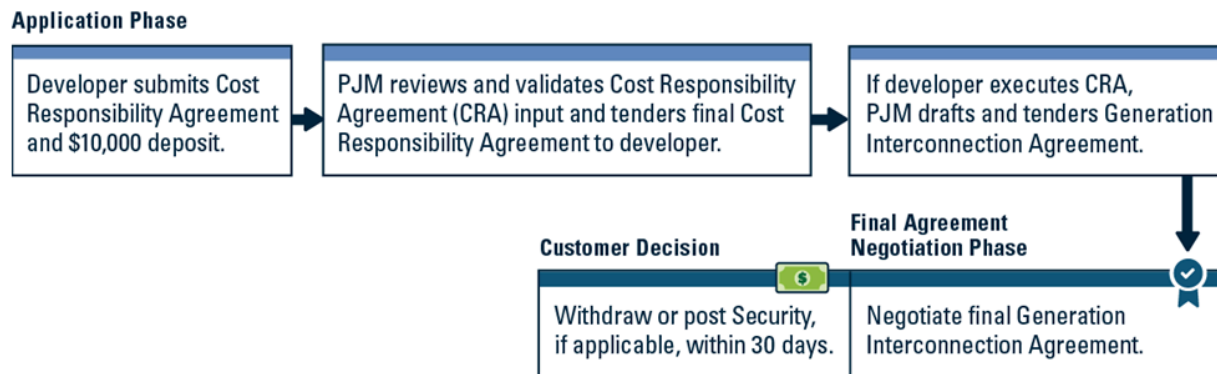

Exhibit 37: Process for conversion from a two-party Interconnection Agreement to a GIA

The procedure for preparing the three party GIA is outlined below:

14.2.1 Application Submission

To initiate the process, the Project Developer submits the following information electronically to PJM:

1. Name of Project Developer
2. Identification of the existing two party agreement, including the expiration date of the agreement
3. Name of Generating Facility
4. Location of Generating Facility. For example, an aerial photograph of the facility with cross streets labeled and a marker for the location of the collector substation location.
5. Point of Contact Information for legal notices
6. Maximum Facility Output
7. Capacity Interconnection Rights
8. Description of the equipment configuration
9. Requested Effective Date of the GIA (if other than upon execution by all parties)

10. Generating Facility Location/Site Plan
11. One-line Diagram of the Facility with Point of Interconnection and Point of Change of Ownership clearly indicated
12. A list of metering equipment and identification of ownership
13. A copy of the current two-party interconnection agreement or power purchase agreement
14. Any additional information requested

14.2.2 Application Review

1. If a completed application is received, PJM assigns a Project Identifier and conducts a deficiency review as outlined below:
 - a. PJM reviews the submission as soon as practicable and notifies the Project Developer of any deficiencies identified.
 - b. The Project Developer responds to the deficiency notice and provides missing information.
 - c. PJM reviews the submission as soon as practicable and notifies the Project Developer, if there are any deficiencies and validates the submission.
2. After all open deficiencies have been addressed, PJM will tender the Cost Responsibility Agreement to the Project Developer for execution.

14.2.3 CRA Execution and Filing

1. Project Developer executes the CRA and provides the \$10,000 deposit to PJM
2. Once the CRA is executed and the study deposit has been provide by the Project Developer, PJM executes the CRA and files the agreement with FERC.

14.2.4 Final Agreement:

14.2.1.1 GIA Draft

After the CRA is fully executed, PJM coordinates with the Project Developer and applicable Transmission Owner to draft the associated final agreements. At PJM's discretion, PJM will schedule meeting(s) with any and all parties to the final agreements and tender to the Project Developer.

14.2.1.2 GIA Execution and Filing

Execution of the GIA under this process follows the same procedures identified in Tariff Part VII, Subpart D, Section 314 and Part VIII, Subpart D, Section 411, Final Agreement Negotiation Phase. The Project Developer will have the same timing requirements to execute necessary agreements as identified in that section of the Tariff.

If construction is required by the Transmission Owner, associated Security and requirements identified in the agreement will also apply.

Upon execution, PJM will file the agreement with or, if conforming, report them to the FERC.

Attachment A: Interconnection Process Flow Diagram

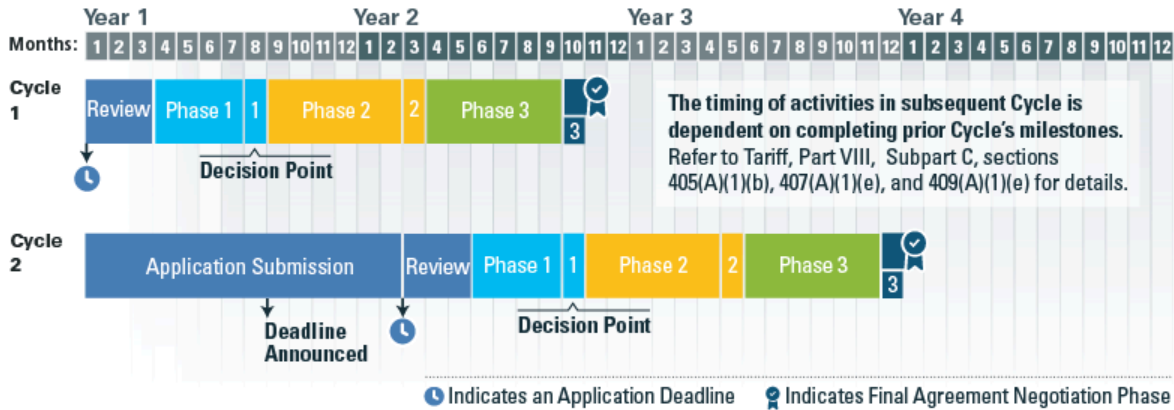

Cycle Dependencies	
<p>Application Deadline of the subsequent Cycle will be announced 180 days prior to the conclusion of prior Cycle's Phase I Decision Point I.</p>	<p>Phase I of the subsequent Cycle will only start after Phase III of the previous Cycle has started AND all Application review period activities have been completed AND base case model has been made available for 30 day review.</p>
<p>Only Completed Applications received by the Application Deadline will be considered for the upcoming Cycle.</p>	<p>Phase II of a subsequent Cycle will only start after Decision Point III of the prior Cycle had concluded.</p>
<p>Applications will only be reviewed during the Application Review Period.</p>	<p>Phase III of the subsequent Cycle will only start after the prior Cycle has concluded.</p>

Attachment B: Cost Allocation Procedures

B.1 Purpose

One of the responsibilities of PJM as an RTO is to allocate the cost responsibility for all system reinforcement projects including projects required for New Service Requests, baseline transmission reliability upgrades, and market efficiency upgrades. The cost allocation procedures used by PJM to allocate costs due to requests are described below. Manual 14B addresses cost allocation procedures for baseline Regional Transmission Expansion Plan (RTEP) transmission reliability and market efficiency projects.

B.2 Scope

System Impact Studies are performed for projects associated with New Service Requests. The results of the System Impact Studies reveal Interconnection Facilities required for new generation to “get to the bus” and Network Upgrades to mitigate any “network impact” effects which the addition of new generation or new transmission facilities may have on the Transmission System itself.

The project’s cost responsibility is described below:

- Each respective generator or transmission project bears the cost responsibility for Interconnection Facilities required for the interconnection.
- The cost responsibility for Network Upgrades identified through each phase of the System Impact Study analysis is allocated among parties as follows:
 - For Network Upgrades that are required due to the overloads associated with the System Impact Studies within a Cycle, the cost of the Network Upgrades will be allocated according to the contribution of each individual New Service Request for those projects which contribute to the need for the Network Upgrades. The Load Flow Cost Allocation methods discussed in this manual, including cutoffs, still apply to the individual projects.
 - For Network Upgrades required due to violations identified by Transmission Owners (TOs) through their local planning criteria, the TO will apply their cost allocation rules or the TO will apply PJM’s cost allocation rules.

B.3 PJM Generation and Transmission Interconnection Cost Allocation Methodologies

The cost allocation procedure will continue to be evaluated and modified, if required, as the interconnection process proceeds.

New Service Requests are studied as a single cluster for all active projects in an individual Cycle. Network Upgrades are identified to mitigate overloads in order to maintain system reliability.

B.3.1 Load Flow Cost Allocation Method

All Project Developers or Eligible Customers with active New Service Requests in an individual Cycle will be allocated a cost for these Network Upgrades based upon the following criteria:

- Contingent to the individual New Service Request contributing (MW impact being greater than 5 MW AND greater than 1% of the applicable facility rating) OR (if its Distribution Factor (DFAX) on the facility is greater than 5% AND greater than 3% of the applicable facility rating), the contribution of a New Service Request project is determined by the voltage level of the facility that it impacts:

For a transmission facility whose monitored element's lowest terminal voltage level is less than 500 kV, a Project Developer or Eligible Customer will have some cost allocation if its Distribution Factor (DFAX) on the facility is greater than 5% OR if its MW impact on the facility's rating is greater than 5%.

- For a transmission facility whose monitored element's lowest terminal voltage level is greater than or equal to 500 kV, a Project Developer or Eligible Customer will have some cost allocation if its DFAX on the facility is greater than 10% OR if its MW impact on the facility's rating is greater than 5%.
- If no New Service Request(s) in a Cycle meet the prior cost allocation thresholds, all non-zero contributors to the facility overload in question who do not receive cost allocation via the prior rules shall be pooled into an aggregate contributor. If the cumulative impact of this aggregate contributor pool exceeds 1% of the applicable line rating, projects with an individual contribution of greater than 0.25% of the applicable line rating will have some cost allocation. If no projects in the aggregate contributor pool contribute greater than 0.25%, the 5 highest contributors in the pool will receive some cost allocation.
 - For New Service Requests involving studies for long-term firm transmission service: seeking to import power to PJM, or which otherwise have their source of power outside PJM, the Eligible Customer will have some cost allocation towards upgrades associated with all PJM Facilities, if its Distribution Factor (DFAX) on the facility is greater than 3% OR if its MW impact on the facility's rating is greater than 3%.
 - Allocation of costs to New Service Requests for a required Network Upgrade will be based on the full MW impact on the facility requiring a Network Upgrade as determined in each phase of System Impact Study. Cost allocation will be based on the highest loading of all test procedures performed (e.g., if Summer Peak overload is more significant than Light Load for the same flowgate, Summer Peak loading will determine cost allocation)

Analysis to determine cost allocation for the engineering design of Network Upgrades will continue to be refined as needed after the Phase III System Impact Study and throughout the

Final Agreement Negotiation Phase. Final resolution of cost allocation will occur using as-built costs upon construction completion.

A complete list of Distribution Factors for all PJM modeled substations will be maintained during System Impact Studies for each identified Network Upgrade. This Distribution Factor list will be used for all cost allocation pertaining to the identified Network Upgrade.

B.3.2 Short Circuit Cost Allocation Method

All active New Service Requests are studied as a single study for all active projects in an individual Cycle. Network Upgrades are identified to mitigate violations in order to maintain system reliability.

A New Service Request will have some cost allocation if the project’s contributing fault current impact on the circuit breaker’s applicable interrupting rating is greater than 1% or if it results in a greater than 1% increase in fault current at the substation. If no single New Service Request project meets these thresholds, the top 5 New Service Requests contributing to the breaker overduty shall receive some cost allocation.

A New Service Request project will be assigned costs in proportion to its fault level contribution or the fault level increase as a result of the inclusion of a new Network Upgrade required by that New Service Request.

If during the course of a short circuit study it is determined that a load flow (or stability) reinforcement subsequently causes breaker(s) to exceed their applicable rating, the cost of breakers identified in this case will be allocated based on the load flow (or stability) cost allocation rules associated with the load flow (or stability) reinforcement as these breaker(s) are considered a part of the load flow (or stability) reinforcement. The contributing fault current from the modeling of the reinforcement is recorded in the event that another queue request does not require the load flow reinforcement, but instead, adds fault current in excess of the normal short circuit threshold of 1% to a breaker. See below for an example of cost allocation for load flow (or stability) driven circuit breaker replacements.

New Service Request Project	MW Contribution	Thermal Upgrade Cost Allocation
CXX-0001	50	50%
CXX-0002	30	30%
CXX-0003	20	20%

Modeling of the thermal upgrade in the short circuit study case results in the contribution of 10kA to a breaker and causes the breaker to be overdutied.

Driver	Fault Contribution (kA)	Short Circuit + Thermal Cost Allocation Impacts (kA)	Total Cost Allocation for Short Circuit Contribution (kA)
Thermal Upgrade	10	N/A	N/A
CXX-0001	2	2+10*0.5 (2 is fault contribution from project generator(s), 10 is fault contribution from reinforcement, 0.5 is 50% cost allocation per thermal analysis)	2+5 = 7
CXX-0002	4	4+10*0.3 (4 is fault contribution from project generator(s), 10 is fault contribution from reinforcement, 0.3 is 30% cost allocation per thermal analysis)	4+3 = 7
CXX-0003	1	1+10*0.2 (1 is fault contribution from project generator(s), 10 is fault contribution from reinforcement, 0.2 is 20% cost allocation per thermal analysis)	1+2 = 3
CXX-0004(Does not require thermal upgrade)	3	3+0	3+0 = 3

The total cost allocation for short circuit contribution is the basis for the determination of the cost allocation towards the breaker upgrade costs. If a breaker replacement costs \$1M, and based on the contributions listed above, the cost allocation for the breaker upgrade is below.

Driver	Total Cost Allocation for Short Circuit Contribution (kA)	Cost Allocation
CXX-0001	2+5 = 7	$(7/(7+7+3+3))*\$1M = \$350k$

CXX-0002	$4+3 = 7$	$(7/(7+7+3+3))*\$1M = \$350k$
CXX-0003	$1+2 = 3$	$(3/(7+7+3+3))*\$1M = \$150k$
CXX-0004	$3+0 = 3$	$(3/(7+7+3+3))*\$1M = \$150k$

Analysis to determine cost allocation for the engineering design of Network Upgrades will continue to be refined as needed after the Phase III System Impact Study and throughout the Final Agreement Negotiation Phase. Final resolution of cost allocation will occur using as-built costs upon construction completion.

PJM will consider application of an individual component cost vs. an aggregate cost when determining the cost allocation window.

B.3.3 Cost Allocation Method for Generator and/or Generator Step Up (GSU) Changes

The generator and generator step up transformer (GSU) characteristics provided by the Project Developer prior to the initiation of the Phase II System Impact Studies for a given Cycle will be used for all cost allocation during the Phase II System Impact Study phase. Project Developers may modify their Interconnection Request for updated equipment data during Decision Point I. During Decision Point II, a Project Developer is limited to modifying their New Service Request to Permissible Technological Advancement changes only.

B.3.4 Stability Cost Allocation Method

All New Service Request projects within a defined electrical region will be studied as a cluster within the current Cycle as established under the PJM Tariff.

If a stability violation is identified during the study of a New Service Request cluster, costs for the required Network Upgrade to eliminate the stability violation will be allocated in proportion to the MFO (or Energy request for an uprate) of each New Services Request in that cluster.

Analysis to determine cost allocation for the engineering design of Network Upgrades will continue to be refined as needed after the Phase III System Impact Study and throughout the Final Agreement Negotiation Phase. Final resolution of cost allocation will occur using as-built costs upon construction completion.

B.3.5 Cost Allocation for Multiple Projects Connecting to the Same Substation

If multiple Project Developers request to connect to the same interconnection substation, the Transmission Owner will determine the cost to accommodate all the requests at the substation. The cost for the interconnection will be allocated in proportion to the number of required terminations into the substation.

The table below shows an example of cost allocation

Project	Number of Terminations	% Allocation for Substation Expansion
Project A	Two	50%
Project B	One	25%
Project C	One	25%

In the event that there is no room for expansion at the substation, the Transmission Owner will provide cost estimate for an electrically equivalent viable alternative, in accordance with Transmission Owner's Applicable Technical Requirements and Standards.

Attachment C: Facilities Study Procedure

C.1 Introduction

A Facilities Study is an engineering study conducted by PJM in collaboration with the Transmission Owner(s) to:

- (1) determine the required modifications to PJM's Transmission System necessary to implement the conclusions of the System Impact Studies; and
- (2) complete any additional studies or analyses documented in the System Impact Studies or required by PJM Manuals, and determine the required modifications to the Transmission Provider's Transmission System based on the conclusions of such additional studies.

Facilities Studies are conducted for Project Developers, Eligible Customers, Upgrade Customers and Affected System Customers hereafter referred to as "customer".

For New Service Requests and Upgrade Requests, the purpose of the Facilities Study is to provide, commensurate with any mutually agreed parameters regarding the scope and degree of specificity described in the Application and Studies Agreement or Upgrade Application and Studies Agreement, an assessment of project related system stability issues and conceptual engineering and, as appropriate, detailed design, plus cost estimates and project schedules, to implement the conclusions of the System Impact Study regarding the Transmission Owner Interconnection Facilities and Network Upgrades necessary to accommodate the New Service Request(s) or Upgrade Request as applicable.

For the Affected System Customer Facilities Study, the purpose of the Affected System Customer Facilities Study is to provide, commensurate with any mutually agreed parameters regarding the scope and degree of specificity described in Schedule A of the Affected System Customer Facilities Study Agreement, an assessment of project related system reliability issues and conceptual engineering and, as appropriate, detailed design, plus cost estimates and project schedules, to implement the conclusions of the Facilities Study regarding the Network Upgrades necessary to accommodate the Affected System interconnection request.

PJM may contract with consultants, including the relevant Transmission Owner (TO) and any other affected Transmission Owners to obtain services or expertise.

C.2 Types of Facilities Studies

C.2.1 Facilities Studies for New Service Requests:

For projects evaluated in PJM's Cycle process, Facilities Studies are conducted in Phase II and Phase III as described below:

1. The Facilities Study for the scope of work for the Project Developer or Eligible Customer to physically interconnect to the Transmission Owner's transmission system will be conducted during Phase II and the Facilities Study report will be included in the System Impact Study report at the end of the phase. The Phase I System Impact Study results will identify the scope of facility additions and upgrades (for the physical interconnection) to be included in the Facilities Study performed in Phase II of the Cycle.
2. The Facilities Study for the scope of work for the Network Upgrades required to mitigate violations identified during the relevant Cycle will be conducted during Phase III and the Facilities Study report will be included in the System Impact Study report at the end of the phase. The Phase II System Impact Study results will identify the scope of Network Upgrades (required to mitigate violations) to be included in the Facilities Study performed in Phase III of the Cycle.

C.2.2 Facilities Studies for Upgrade Requests:

Facilities Study for an Upgrade Request is performed during the Facilities Study Phase of the relevant Upgrade Process.

The System Impact Study results will determine the scope of facility additions and upgrades to be included in the study.

C.2.3 Facilities Studies for Affected System Customers

An Affected System Customer responsible for an Affected System Facility that requires Network Upgrades to the PJM System must contact PJM to initiate a Facilities Study. Upon contact, PJM will provide the Affected System Customer with an Affected System Facilities Study Agreement (a form of which is found in Tariff, Part IX). PJM will conduct a Facilities Study following the process outlined in Tariff, Parts VII, Subpart G, section 336 (B) and VIII, Subpart G, section 434 (B).

Schedule A of the Affected System Customer Facilities Study Agreement outlines the scope of facility additions and upgrades to be included in the Facilities Study.

C.3 General Facilities Study Guidelines

Facilities Study work may be initiated by a kickoff meeting attended by the Transmission Owner, affected Transmission Owner(s), the customer, and PJM, as determined by PJM.

The following types of information will be reviewed at the kickoff meeting:

The customer shall provide a schedule for construction and anticipated commercial operation of the customer's facilities. The customer's schedule shall include the date when backfeed power is required, and the dates for anticipated test and commercial operation of each generating unit or transmission facility.

The scope of the customer's, PJM's, Transmission Owner and other affected TO's facilities work will be reviewed on the call, as applicable.

C.4 Facilities Studies Report

Results of PJM's Facilities Study shall be reported to the customer in the form of a Facilities Study report or included in the relevant System Impact Study Report published at the end of the phase in which the study is conducted ("the Report").

The Report must contain a good-faith estimate of costs and construction schedules for each new or upgraded facility.

In addition, the Report must contain sufficient detail about the engineering design of each facility. This will provide the customer with information necessary to perform due diligence on the work to be performed by PJM, the Transmission Owner and other affected TO(s).

The Report, without confidential or sensitive material, will be integrated with other Reports from other affected Transmission Owners (if applicable), and will also be posted on PJM's Website.

Facilities Study reports submitted to PJM shall consist of two primary sections:

- (1) Transmission Owner Facilities Study Summary
- (2) Transmission Owner Facilities Study Results

C.4.1 Transmission Owner Facilities Study Summary

A summary of the contents of the Transmission Owner Facilities Study Summary section of the Facilities Study report is provided below.

C.4.1.1 Description of Project

This section provides a general description of the customer's project that resulted in the need for the addition and/or upgrade of facilities.

The most recent information available to the Transmission Owner at the start of the applicable System Impact Study Phase shall be used as the basis for the project description.

C.4.1.2 Customer's Submitted Milestone Schedule

The Customer's submitted project schedule will be documented in the Facility Study report..

C.4.1.3 Scope of Customer's Work

In general, for New Service Requests, the scope of the Project Developer's facility study work will be limited to the facilities up to, but not including, the Point of Interconnection to a TO's facilities. The Project Developer's facilities study results will be included in the report to the extent required to adequately support PJM's Facility Study results.

C.4.1.4 Description of Facilities Included in the Facilities Study

This section includes a general description of transmission lines, substations, protection systems, etc. that are included in the Facilities Study Report.

C.4.1.5 Total Costs of Transmission Owner Facilities included in Facilities Study

This section includes a summary level statement indicating the total estimated costs for both Transmission Owner Interconnection Facilities and Network Upgrades included in the Facilities Study, as applicable.

C.4.1.6 Summary of Milestone Schedules for Completion of Work Included in Facilities Study

This section includes a summary level schedule for detailed design, material & equipment procurement, and construction & testing for Transmission Owner Interconnection Facilities and Network Upgrades included in Facilities Study.

This section should include a statement of comparison (i.e. alignment or misalignment) with Project Developer's milestone schedule.

C.4.2 Transmission Owner Facilities Study Results

C.4.2.1 Transmission Lines – New

The Facilities Study shall include any new Transmission lines that will be constructed. The Report shall include a "purpose and necessity" statement as well as a general description of alternative routes, terminal points, geographic description of terrain traversed by the new line, right-of-way width by segment, potential use of common corridors where such use exists, and a description of the permits required.

The following information must also be provided:

1. design criteria (may be summarized and reference published documents)
2. nominal voltage rating
3. physical characteristics (overhead, underground, single circuit, double circuit, AC, DC, etc.)
4. line MVA normal and emergency rating, basic insulation level (BIL), line impedance (positive and zero sequence)
5. line and shield conductor type and size

6. type of support structure, and grounding design
7. Applicable Transmission Owner Technical Standards should be referenced in the Report.
8. A specific reference to “PJM Transmission and Substation Design Subcommittee Technical Requirements” (note: upon approval) must be made for new or upgraded facilities.
9. Material specifications and a materials list, if available, may be included in the report or referenced.
10. All permit requirements must be identified.
11. Attachments required: geographic map with Project Developer facility location/site plan, with proposed transmission line study area superimposed.
12. Attachments optional: drawings for typical structure types.

C.4.2.2 Transmission Line – Upgrades

The Facilities Study shall include any existing transmission lines that will be upgraded. As applicable, the same information, as listed above for “Transmission Lines – New”, distinguishing between existing and new equipment.

Attachments: As applicable, same as above for “Transmission Lines – New”.

C.4.2.3 New Substation/Switchyard Facilities

New substation and switchyard facilities to be constructed will be identified in the Facilities Study report. The report shall include:

1. A “purpose and necessity” statement, a general description of the functional station design and layout, proposed location, and a description of the potential permits required.
2. A description of the structural design, the electrical design including rating specifications and rating for all major electrical equipment (e.g. power transformers, circuit breakers, switches, instrument transformers, capacitor voltage transformers, etc.), and the protective relaying, communications, metering, and instrumentation requirements.
3. Applicable Transmission Owner Engineering and Construction Standards should be referenced in the Report.
4. A specific reference to any Transmission Owner technical guidelines and recommendations (e.g. TSS technical guidelines) must be made for new or upgraded facilities.
5. A specific reference to any protection relay philosophy and design guidelines (e.g. RS technical design philosophy) must be made for new or upgraded protective relay equipment.
6. Material specifications and a materials list, if available, may be included in or referenced in the report.
7. All permit requirements must be identified.

8. Attachments required: One-line diagram for each substation / switchyard where facilities are to be added or upgraded. General arrangement diagram showing the physical layout of the new substation facilities.
9. Optional Attachment: Relay, Instrumentation, and Control one-line diagram.

C.4.2.4 Upgrades to Substation / Switchyard Facilities

The Facilities Study shall include any existing substation / switchyard facilities that will be upgraded. As applicable, the same information listed above for “New Substation / Switchyard Facilities”, distinguishing between existing and new equipment.

Attachments: As applicable, same as above for “New Substation / Switchyard Facilities”.

C.4.2.5 Metering & Communications

General requirements for revenue and telemetry metering, SCADA RTU, and telecommunications, coordinated with PJM requirements.

C.4.2.6 Environmental, Real Estate and Permitting Issues

Assessment of environmental impacts related to Transmission Owner Interconnection Facilities and/or Network Upgrades (i.e. Environmental Impact Study requirements, environmental permitting, sediment & erosion control issues), real estate ownership / easement issues, siting and Right-of Way issues for the Transmission Owner side of Point of Interconnection.

C.4.2.7 Summary of Results of Study

Cost Estimates

A table listing construction cost estimates for each new or upgraded facility shall be provided. As applicable, the table will identify and include all taxes and additional charges such as CIAC.

At a minimum, cost estimates shall be included with the following level of detail, along with the total costs (keeping applicable cost in aid of construction (CIAC) tax gross-up amounts separate from total costs). Include both direct and indirect costs in each cost category.

For Transmission Owner Interconnection Facilities:

1. Detailed Design Costs
2. Material and Equipment Costs
3. Construction and Testing Costs
4. Miscellaneous Costs (i.e., real estate fees, environmental studies, contingencies, project management/oversight – specify details)
5. CIAC Tax Gross-up (if applicable)

For each Network Upgrade:

1. Detailed Design Costs
2. Material and Equipment Costs
3. Construction and Testing Costs
4. Miscellaneous Costs (i.e., real estate fees, environmental studies, contingencies, project management/oversight – specify details)
5. CIAC Tax Gross-up (if applicable)

Additional level of detail for cost estimates shall be provided if indicated in Schedule A of the Facilities Study agreement.

C.4.2.8 Schedules

The following relating to schedule for completion of each required upgrade shall be included:

1. A milestone schedule, including major milestones (e.g. completion of final design, prepare specifications, solicit bids, construction completion) shall be provided for all facilities within PJM's and the TO's scope of work.
2. A statement concerning the ability to meet the customer's scheduled milestones must be included.
3. Additional level of detail for project schedule shall be provided if indicated in the Facilities Study agreement.

C.4.2.9 Assumptions

The following should be included in the Report:

1. A list of assumptions, uncertainties and / or qualifiers that may adversely impact the estimated costs and/or schedules must be identified.
2. Some examples of items to be detailed in this section are:
 - a. environmental permitting
 - b. real estate / easement acquisition
 - c. public / customer opposition
 - d. equipment availability / system constraints / time of year limitations,
 - e. scope definition with respect to accelerated schedule
 - f. contractor cost variability.

C.4.2.10 Information Required for Interconnection Related Agreement

A table with a cost breakdown for the FERC filing of the final interconnection related agreement must be provided. The table shall include the total cost for all facilities to be constructed by the TO. The costs must be itemized in the following categories:

Transmission Owner Interconnection Facilities:

1. Direct Charges Labor
2. Direct Charges Materials
3. Indirect Charges Labor
4. Indirect Charges Material
5. Carrying Charges*

Network Upgrades:

1. Direct Charges Labor
2. Direct Charges Materials
3. Indirect Charges Labor
4. Indirect Charges Material
5. Carrying Charges*

* The Carrying Charge Rate must be specified.

The cost breakdown indicated above is for use in the GIA in accordance with FERC guidelines.

Types of Facilities Study Costs

The following are definitions for the above cost types:

Direct Costs: These are costs directly associated with the project. These costs need to be separated into:

1. "Direct Labor" costs which include the cost of labor to design/build/install the upgrades or facilities, and
2. "Direct Material" costs which include the cost of the physical upgrades and equipment.

Indirect Costs: These costs include general and administrative expenses such as the salary of the payroll clerk.

Carrying Charges: These costs are the time value of money associated with the project (i.e., allowance for funds used during construction (AFUDC)). The interest rate must be specified.

Attachment D: HVDC Additional Study Requirements

In addition to the studies normally required interconnection during the Phase III System Impact Study by PJM and the Transmission Owner, several other studies are required among PJM, Transmission Owner, and the Transmission Project Developer to facilitate proper design of an HVDC facility. Though many of the studies listed below will be required by the Project Developer for proper design of the HVDC facilities, PJM and member Transmission Owners require independent verification of the expected performance of the facilities being interconnected.

D.1 Proposed Merchant D.C. Transmission Facilities and Their Dynamic Characteristics

The Transmission Project Developer needs to provide to PJM proposed operating performance specifications, dynamics characteristics and models of the HVDC facilities in the Application Phase. This would include but not limited to

- Proposed control modes (e.g. power control, power factor control)
- Proposed power modulation controls
- Expected recovery times after AC or DC side faults
- Proposed reactive compensation

D.2 Dynamic Performance Analysis

This study assesses the dynamic performance of an HVDC project to disturbances on both the DC and AC system. It is typically performed using various simulation tools such as PSS/E, EMTDC, EMTP, HYPERSIM, MATLAB/SimPower, etc. The dynamic performance is demonstrated by time domain analysis for a list of system disturbance cases generally based on applicable NERC, Regional, PJM and Transmission Owner criteria that will include, but not limited to:

- DC side faults
- Energization of the Merchant D.C. Transmission Facilities
- DC facility step response
- Blocking and De-Blocking of the Merchant D.C. Transmission Facilities
- AC side faults (Temporary or Permanent, single phase or multi-phase) considering reclosing, breaker failure, delayed clearing, and loss and recovery performance of DC tie for faults near converter or inverter terminal.
- Tripping of generation or Switching of large loads in the proximity of DC terminal

Assessment of the dynamic performance will also include analysis of possible dynamic overvoltages/undervoltages on the AC network. In addition to the above listed phenomena, additional events to be studied, but not limited to

- Switching of HVDC facility's AC filters, bus voltage control devices
- Switching of nearby transformers, reactors, capacitor banks etc.

D.3 Sub-synchronous Torsional Analysis

Torsional perturbations in a turbine-generator could cause modulations of the generator's rotor speed, which in turn could cause variations in the generator's terminal voltage. If an HVDC converter terminal is in the electrical proximity, this could cause variations in the DC side voltages and currents. Regulators within the DC terminal could respond to these changes, which in turn could cause changes in the machine's electrical torque. If this change in torque is out of phase with the change in speed, it could provide negative damping to the torsional vibrations amplifying their effects, which could damage the turbine-generator shaft.

The possibilities of torsional interactions between HVDC converter and the generator would depend on relative coupling between the two, their relative sizes, and the phase lag from perturbation in generator speed to the perturbation in generator electrical torque including the actions of the HVDC controls.

A screening study is performed to determine if there is any risk of torsional interactions over the entire range of expected operating conditions. If a risk of torsional interactions is identified, more detailed studies would be required to help design HVDC controls to minimize such a risk, and if necessary to design Torsional Protection for the generator at risk.

D.4 AC System Harmonic Analysis

This study is to assess the impact of an HVDC project on the power quality of the local AC electrical system and to validate the suitability of the design of AC filters associated with the DC terminals over the range of operation of the facility. The study is performed to demonstrate that there will be no unacceptable harmonic impact of the AC system, and that the facility will meet performance criteria and standards on power quality. If necessary, mitigation solutions would be identified. IEEE Std. 519 will be used if no local utility standard is available.

D.5 Studies required by Transmission Owner's FERC-715 report

PJM and the affected Transmission Owner will require verification of design and/or expected performance of the proposed HVDC facilities to meet requirements as listed in the Interconnected Transmission Owner's FERC-715 filing.

D.6 A.C. Ferro-Resonance Study

PJM and/or the Transmission Owner will evaluate the results of the ferro- resonance study to be performed by the Transmission Project Developer.

D.7 Power Line Carrier Filter Performance Verification

PJM and/or the Transmission Owner will evaluate the results of the power line carrier blocking filter design study to be performed by the Transmission Project Developer.

D.8 Field Investigation of Existing A.C. System Harmonic Content

This study will measure and analyze the existing harmonics and negative phase sequence content at the Point of Interconnection between the Transmission Owner and the Transmission Project Developer's project.

D.9 Stability Analyses

PJM and/or the Transmission Owner will provide data listed in the table below to the Transmission Project Developer. Information included in the table indicates the A.C. power system characteristics at the Point of Interconnection to be used in design of the project. Each converter terminal's Point of Interconnection shall be provided.

AC Network Parameter	Substation No.1	Substation No. 2
Nominal AC Line Voltage	kV	kV
Base AC Voltage	kV	kV
Normal Operating Line Voltage (range)	kV	kV
Maximum Steady State Line Voltage	kV	kV
Minimum Steady State Line Voltage	kV	kV
Negative Sequence Voltage During Normal Operation	%	%
Nominal System Frequency	Hz	Hz
Steady State Maximum Frequency	Hz	Hz
Steady State Minimum Frequency	Hz	Hz
Frequent Disturbance Frequency Deviation	±Hz	±Hz

Infrequent Disturbance Frequency Deviation - 10 - 12 % Load Shedding	_ % Load Shedding ±Hz	_ % Load Shedding ± Hz
Infrequent Disturbance Frequency Deviation - 50% Load Shedding	≥Hz	≥Hz
Maximum Phase Current Unbalance	%	%
Maximum Short Circuit	MVA, 3-PH MVA, 1-PH	MVA, 3-PH MVA, 1-PH
Ultimate Maximum Short Circuit	MVA, 3-PH	MVA, 3-PH
Minimum Short Circuit	MVA, 3-PH MVA, 1-PH	MVA, 3-PH MVA, 1-PH
Maximum Positive Sequence System Impedance (100 MVA base)	+j PU	+j PU
Maximum Zero Sequence System Impedance (100 MVA base)	+j PU	+j PU
Minimum Positive Sequence System Impedance (100 MVA base)	+j PU	+j PU
Minimum Zero Sequence System Impedance (100 MVA base)	+j PU	+j PU
AC System Fault Clearing Time Normal	cycles	cycles
AC System Fault Clearing Time – Breaker Failure	cycles	cycles
Automatic Reclosing Time(1-PHASE) (3-PHASE) Instantaneous Delayed	cycles cycles cycles	cycles cycles cycles
Switchyard Equipment BIL (LIWL)	kV	kV
Switchyard Equipment SIL (SIWL)	kV	kV

Exhibit 38: Table AC Power System Characteristics at the Point of Interconnection

Attachment E: Transmission Injection Rights and Transmission Withdrawal Rights

E.1 Summary of Transmission Injection Rights (TIRs) and Transmission Withdrawal Rights (TWRs)

The assignment of TIRs and TWRs associated with new Merchant D.C. Transmission Facilities or Controllable A.C. Transmission Facilities will be made in accordance with the PJM Tariff and may depend upon the capabilities of the facilities and upgrades necessary to accommodate other New Service Requests. TIRs and TWRs are defined in PJM Tariff Part VII, Subpart E, section 330 and Part VIII, Subpart E, section 428.

The holder of TIRs is entitled to schedule energy on the associated Merchant D.C. Transmission Facilities or Controllable A.C. Transmission Facilities for injection into the PJM Transmission System at the defined Point of Interconnection between the Merchant D.C. Transmission Facilities or Controllable A.C. Transmission Facilities and the PJM Transmission System. TWRs entitle the holder to schedule energy on the associated Merchant Transmission Facilities to be withdrawn from the PJM Transmission System at the defined Point of Interconnection between the Merchant D.C. Transmission Facilities or Controllable A.C. Transmission Facilities and the PJM Transmission System.

This capability to inject energy at a defined Point of Interconnection with the PJM Transmission System is directly comparable to the capability of generation facilities to inject capacity/energy into the PJM Transmission System. Similarly, the capability to withdraw energy at a defined Point of Interconnection with the PJM Transmission System is directly comparable to the capability of load to withdraw capacity/energy from the PJM Transmission System.

TIRs and TWRs are available to developers of Merchant D.C. Transmission Facilities or Controllable A.C. Transmission Facilities only if the Transmission Project Developer has elected, pursuant to the PJM Tariff, to receive Transmission Injection Rights and Transmission Withdrawal Rights in lieu of Incremental Deliverability Rights, Incremental Auction Revenue Rights, and Incremental Capacity Transfer Rights. The holder of TIRs and TWRs for Merchant D.C. Transmission Facilities and/or Controllable A.C. Transmission Facilities that interconnect with the PJM Transmission System and with a control area outside the combined PJM Region shall be entitled to receive Transmission Injection Rights and/or Transmission Withdrawal Rights at each terminal where such Merchant D.C. Transmission Facilities and/or Controllable A.C. Transmission Facilities interconnect with the PJM Transmission System. The MW value of TIRs requested and/or held at one terminal of Merchant D.C. Transmission Facilities or Controllable Merchant A.C. Transmission facilities shall be the net of all losses on the facility. The value of TWRs requested and/or held shall be the actual MW value to be withdrawn.

A Transmission Project Developer may hold TIRs and TWRs simultaneously at the same terminal on the PJM Transmission System, subject to PJM evaluation and approval. However, neither the aggregate TIRs nor the aggregate TWRs held at a terminal may exceed the Nominal Rated Capability (as defined in the PJM Tariff) of the interconnected Merchant D.C. Transmission Facilities and/or Controllable A.C. Merchant Transmission Facilities, as stated in the associated Generation Interconnection Agreement.

Subject to the terms of the PJM Tariff, TIRs and/or TWRs received by a party shall be effective for the life of the associated Merchant D.C. Transmission Facilities and/or Controllable A.C. Merchant Transmission Facilities.

No TIRs or TWRs shall be received by a party with respect to transmission investment that is included in the rate base of a public utility and on which a regulated return is earned.

TIRs and/or TWRs may be sold or otherwise transferred subject to compliance with such procedures as PJM may establish regarding such transfer and required notice to PJM of use of such rights after the transfer. The transfer of TIRs or of TWRs shall not itself extend the time periods set forth in the PJM Tariff regarding loss of such rights.

E.2 Procedure to Determine Transmission Injection Rights (TIRs) and Transmission Withdrawal Rights (TWRs)

Transmission Injection Rights (TIRs) are the rights to schedule energy transmitted on the associated Merchant D.C. Transmission Facilities and/or Controllable A.C. Merchant Transmission Facilities for injection into the Transmission System, at a Point of Interconnection of the Merchant D.C. Transmission Facilities and/or Controllable A.C. Merchant Transmission Facilities with the Transmission System.. TIRs are determined through the use of industry power flow software and analytical techniques to be the amount of capacity and/or energy that can be reliably accommodated for injection into the Transmission System at the Point of Interconnection. The studies to determine Capacity (Firm) TIRs are conducted under the same reliability criteria as studies for projects requesting Capacity Interconnection Rights and RTEP baseline studies. Studies to determine Energy (Non-Firm) TIRs are conducted under the same reliability criteria as studies for projects requesting only Energy Resource Status and RTEP baseline studies.

Transmission Withdrawal Rights (TWRs) are the rights to schedule for transmission on the associated Merchant D.C. Transmission Facilities and/or Controllable A.C. Merchant Transmission Facilities energy to be withdrawn from the Transmission System, at a Point of Interconnection of the Merchant D.C. Transmission Facilities and/or Controllable A.C. Merchant Transmission Facilities with the Transmission System. TWRs are determined through the use of industry power flow software and analytical techniques to be the amount of capacity and/or energy that can be reliably accommodated for withdrawal from the Transmission System at the Point of Interconnection. The studies to determine Firm and Non-Firm TWRs are conducted under the same reliability criteria as applied in the RTEP baseline studies.

PJM shall include in the System Impact Study an evaluation of the feasibility of the Transmission Injection Rights and the Transmission Withdrawal Rights (including the quantity of each type of such rights) requested by the Transmission Project Developer at the terminal(s) where the pertinent Merchant D.C. Transmission Facilities and/or Controllable A.C. Merchant Transmission Facilities interconnect with the PJM Transmission System. Such rights shall become available to the Transmission Project Developer pursuant to the Generation Interconnection Agreement and upon commencement of Interconnection Service thereunder.

E.3 Transmission Service Rate for TWR

There are two components to transmission service requirements to deliver transactions out of PJM over Merchant D.C. Transmission Facilities.

E.3.1 Subscription for transmission service over Merchant D.C Transmission Facilities.

Assuming that the HVDC facility has elected TIRs and TWRs instead of possible incremental rights, transmission service over the facility would be obtained and scheduled according to the subscription for service over the HVDC facility, regardless of which RTO retains operational control of the Merchant D.C. Transmission Facilities.

E.3.2 Transmission service from the source(s) in PJM to the HVDC terminal in PJM.

The Transmission Project Developer can choose either Point-To-Point Transmission Service or Network Integration Transmission Service, depending on their respective circumstances. Only Point-To-Point Transmission Service is available for service to non-designated loads. The only exception that provides for use of Network Integration Transmission Service is for a Network Customer that requests transmission service for load outside of PJM and elects to include its entire load as Network Load for all purposes.

Attachment F: Incremental Auction Revenue Rights

F.1 Incremental Auction Revenue Rights

Incremental Auction Revenue Rights (IARRs) are the additional Auction Revenue Rights, not previously feasible, created by the addition of Incremental Rights-Eligible Required Transmission Enhancements, Merchant Transmission Facilities, or of one or more Customer-Funded Upgrades. PJM Tariff defines IARRs in PJM Tariff, Parts Part VII, Subpart A, section 300 and VIII, Subpart A, section 400 and explains them in Parts VII, Subpart E, section 329 and VIII, Subpart E, section 427.

No Incremental Auction Revenue Rights shall be received by Transmission Project Developer or Upgrade Customer with respect to transmission investment that is included in the rate base of a public utility and on which a regulated return is earned.

F.1.1 Transmission Project Developers

Incremental Auction Revenue Rights are available to developers of Merchant D.C. Transmission Facilities and/or Controllable Merchant A.C. Transmission Facilities only if the developer has elected, pursuant to the PJM Tariff, to receive Incremental Auction Revenue Rights, Incremental Deliverability Rights and Incremental Capacity Transfer Rights in lieu of Transmission Injection Rights and/or Transmission Withdrawal Rights.

F.1.2 Upgrade Customers

Upgrade Requests by Upgrade Customers requesting Incremental Auction Revenue Rights are initiated by submission of a complete and executed Upgrade Application and Studies Agreement (a form of which is located in Tariff, Part IX, Subpart K).

Incremental Auction Revenue Rights are the additional Auction Revenue Rights, not previously feasible, created by the addition of Incremental Rights-Eligible Required Transmission Enhancements, Merchant Transmission Facilities, or of one or more Customer-Funded Upgrades. An Upgrade Customer requesting IARRs per Section 7.8 of the Appendix to Tariff Attachment K requests PJM to determine the upgrades necessary to create the requested incremental ARR financial rights requested. The maximum level to be awarded of the IARRs is 100% of requested amount, and the minimum level to be awarded is 80% of the IARRs requested.

Upgrade Customers funding Merchant Network Upgrades and requesting Incremental Auction Revenue Rights can request up to three (3) pairs of point-to-point combinations (source/sink pairs).

F.2 Procedure to Determine Incremental Auction Revenue Rights (IARRs)

Auction Revenue Rights (ARRs) are the rights of an ARR holder to an appropriate portion of the revenues from the annual Financial Transmission Right Auction. Incremental ARR are those additional ARRs, not previously feasible, created by the addition of Incremental Rights-Eligible Required Transmission Enhancements, Merchant Transmission Facilities, or of one or more Customer-Funded Upgrades.

The Incremental ARRs are determined pursuant to Tariff, Parts VII, Subpart E, section 329(A)(2) and VIII, Subpart E, section 427(A)(2) using the tools described in Tariff, Attachment K, including an assessment of the simultaneous feasibility of any Incremental ARRs and all other outstanding ARRs.

For each requested point-to-point combination, PJM shall determine, simultaneously with all other requested point-to-point combinations, the base system ARRs capability, excluding the impact of any new transmission facilities or upgrades necessary to accommodate New Service Requests or Upgrade Requests.

The Office of the Interconnection then shall similarly determine, for each requested point-to-point combination, the ARRs capability, including the impact of any new transmission facilities or upgrades.

For each point-to-point combination, the Incremental ARRs capability shall be the difference between the ARRs capability in the base system analysis and the ARRs capability in the analysis including the impact of the new transmission facilities and upgrades.

When multiple Transmission Project Developers or Upgrade Customers have cost responsibility for the same new transmission facility or upgrade, IARRs shall be assigned to each Transmission Project Developer or Upgrade Customer in proportion to the Transmission Project Developer's or Upgrade Customer's relative cost responsibilities for the facility and in inverse proportion to the relative flow impact on constrained facilities or interfaces of the point-to-point combinations selected by the Transmission Project Developer or Upgrade Customer.

The Incremental ARRs created by the addition of Merchant Transmission Facilities or Merchant Network Upgrades are determined through the use of industry power flow software and analytical techniques. The studies to determine the Incremental ARRs are conducted under the same reliability criteria as Energy Resources and baselines.

Attachment G: Incremental Deliverability Rights

G.1 Incremental Deliverability Rights

Incremental Deliverability Rights (IDRs) are the rights to the incremental ability, resulting from the addition of a Merchant Transmission Facilities, to inject capacity and energy at a point on the Transmission System, such that the injection satisfies the deliverability requirements of a Capacity Resource. Deliverability is the determination that the aggregate of regional capacity resources can be utilized to deliver energy to the aggregate of regional load consistent with the requirements of the Reliability Principles and Standards of the applicable regional reliability council.

PJM Tariff, Parts VII, Subpart A, section 300 and VIII, Subpart A, section 400 define IDRs and PJM Tariff, Parts VII, Subpart E, section 329 and VIII, Subpart E, section 427 explain IDRs further.

A Transmission Project Developer shall be entitled to receive the Incremental Deliverability Rights associated with its Merchant Transmission Facilities as determined in accordance with the PJM Tariff, provided, however, that a Transmission Project Developer that proposes to interconnect Merchant D.C. Transmission Facilities and/or Controllable Merchant A.C. Transmission Facilities that connect the Transmission System with another control area shall be entitled to Incremental Deliverability Rights associated with such Merchant D.C. Transmission Facilities and/or Controllable Merchant A.C. Transmission Facilities only if the Project Developer has elected, pursuant to the PJM Tariff, to receive Incremental Auction Revenue Rights, Incremental Capacity Transfer Rights, and Incremental Deliverability Rights in lieu of Transmission Injection Rights and/or Transmission Withdrawal Rights.

Incremental Deliverability Rights assigned to a Transmission Project Developer shall be effective until the earlier of the date that is one year after the commencement of Interconnection Service for such customer or the date that such Transmission Project Developer's New Service Request is withdrawn and terminated, or deemed to be so, in accordance with the Tariff.

No Incremental Deliverability Rights shall be received by a Transmission Project Developer with respect to transmission investment that is included in the rate base of a public utility and on which a regulated rate of return is earned.

G.2 Procedure to Determine Incremental Deliverability Rights (IDRs)

Incremental Deliverability Rights (IDRs) are the additional reliable injection capability at that same point on the Transmission System created by the addition of Merchant Transmission Facilities. IDRs represent the additional Deliverability Capability created by the addition of Merchant Transmission Facilities resulting from the accommodation of the Transmission

Interconnection Request. The IDRs are determined to be the difference between the Deliverability Capability available at that point after the installation of the additional transmission facilities and the Deliverability Capability available at that point immediately prior to the installation of the additional transmission facilities.

PJM shall include in the System Impact Study a determination of the IDRs associated with the Transmission Project Developer's Merchant Transmission Facilities.

PJM shall post on its OASIS the IDRs that it assigns to the Transmission Project Developer. The IDRs created by the addition of Merchant Transmission Facilities are determined through the use of industry power flow software and analytical techniques. The studies to determine the IDRs are conducted under the same reliability criteria as studies for projects requesting Capacity Status and RTEP baseline studies.

Note:

Refer to Manual 14-B for a full description of the deliverability testing methodology.

Attachment H: Incremental Capacity Transfer Rights and Qualified Transmission Upgrades

H.1 General ICTR Information

Incremental Capacity Transfer Rights (ICTRs) are allocated to a Generation Project Developer or Transmission Project Developer obligated to fund a transmission facility or upgrade to the extent such upgrade or facility increases the import capability into a Locational Deliverability Area (LDA), or allocated to a Responsible Customer in accordance with PJM Tariff, Schedule 12A. ICTRs are described in PJM Tariff Part VII, Subpart E, section 329 and Part VIII, Subpart E, section 427. Such Incremental Capacity Transfer Rights allocation is based on the incremental increase in import capability across a Locational Constraint that is caused by the transmission facility upgrade. Incremental Capacity Transfer Rights will be effective for thirty years or the life of the facility or upgrade, whichever is less.

A Transmission Project Developer that interconnects Merchant Transmission Facilities with the Transmission System shall be entitled to receive any Incremental Capacity Transfer Rights that are associated with the interconnection of such Merchant Transmission Facilities as determined in accordance with the PJM Tariff.

In addition, an Upgrade Customer that (a) reimburses PJM for the costs of constructing or completing Customer-Funded Upgrades, or (b) pursuant to its Construction Service Agreement undertakes responsibility for constructing or completing Customer-Funded Upgrades shall be entitled to receive any ICTRs associated with such required facilities and upgrades as determined in accordance with the PJM Tariff.

A Transmission Project Developer (a) that interconnects Merchant D.C. transmission Facilities and/or Controllable A.C. Merchant Transmission Facilities with the Transmission System, one terminus of which is located outside the PJM Region and the other terminus of which is located within the PJM Region, and (b) that will be a Merchant Transmission Provider, shall not receive any ICTRs with respect to its Merchant D.C. Transmission Facilities and/or Controllable A.C. Merchant Transmission Facilities.

PJM shall not include available transfer capability at the interface(s) associated with such Merchant D.C. Transmission Facilities and/or Controllable A.C. Merchant Transmission Facilities in its calculations of Available Transfer Capability under PJM Tariff, Attachment C.

H.2 Procedure to Determine ICTRs

A Transmission Project Developer or Upgrade Customer wishing to request ICTRs must provide PJM with three Load Deliverability Areas (LDAs) to determine the rights. Once submitted, PJM will provide the amount of rights that will be received in the System Impact Study.

Participants must request PJM to certify the ICTRs into the constrained LDAs modeled in Reliability Pricing Model (RPM) at least 90 days prior to the Base Residual Auction. PJM will certify the Incremental CTRs into the constrained LDA at least 45 days prior to the Base Residual Auction. For LDAs in which the RPM Auctions for such Delivery Year result in a positive average weighted Locational Price Adder with respect to the immediate higher level LDA, the holder of a Participant-Funded ICTR into such LDA shall receive a payment equal to (i) average weighted Locational Price Adder for the LDA into which the associated facility or upgrade increased import capability, multiplied by (ii) MW amount of ICTRs allocated to holder. No payment will be issued to the holder when a zero or negative average weighted Locational Price Adder with respect to the immediate higher level LDA is calculated as a result of the RPM Auctions for such Delivery Year. Participant-Funded ICTRs may be traded similar to CTRs.

Attachment I: Transition Procedures

I.1 Introduction

On November 29, 2022, the Federal Regulatory Commission (or “FERC”) conditionally accepted PJM’s filing (Docket No. ER22-2110) to modify its Open Access Transmission Tariff (“Tariff”) to incorporate a comprehensive reform of the PJM interconnection process designed to more efficiently and timely process New Service Requests by transitioning from a serial “first-come, first-served” queue approach to a “first-ready, first-served” Cycle approach. In addition to the new rules outlined in the filing, the filing also outlined the procedures and rules for the transition from the prior interconnection process to the new process (“Transition Period Rules”) set forth in PJM Tariff, Part VIII.

The Transition Period Rules, to which this Transition Document applies, set forth in PJM Tariff, Part VII, became effective January 3, 2023.

PJM requested in the filing that the Transition Date to the new process will be the later of:

1. The effective date of the Transition Period Rules
2. The date by which all AD2 and prior projects’ Interconnection Service Agreements (“ISA”), Wholesale Market Participation Agreements (“WMPA”) or Upgrade Construction Service Agreement (“UCSA”) have been executed or filed unexecuted.

Given that the Transition Period Rules effective date of January 3, 2023 has passed, the Transition Date will be the No. 2 date above.

This attachment summarizes the Transition Period Rules, which will apply to projects in the AE1 through AH1 queues that have not been tendered or executed an ISA, WMPA or UCSA as of the Transition Date.

Tariff, Part VII outlines in full detail, the procedures and other terms governing PJM’s administration of the transition to the new Cycle process, including:

1. procedures and other terms regarding studies and other processing of New Service Requests during the Transition Period;
2. the nature and timing of the agreements required within a Transition Cycle in connection with the studies and construction of required facilities; and
3. the terms and conditions relating to the rights available to Project Developers (formerly referred to as Interconnection Customers), Eligible Customers and Upgrade Customers under the Transition Period Rules.

In the event that there is a conflict between the contents of this document and the Tariff, the Tariff shall govern.

Capitalized terms not defined herein have the meaning set forth in Tariff, Part VII.

I.1.1 Applicability

This attachment applies to any project for which the Project Developer, Eligible Customer or Upgrade Customer has submitted a New Service Request between April 1, 2018 and September 30, 2021 (AE1- AH1 New Service Requests), and for which, as of the Transition Date, PJM has not tendered for execution an ISA, WMPA or UCSA.

The following chart shows the timeframes of the various queue periods:

QUEUE WINDOW TIME PERIODS

Queue Window	Time Period
AD2 and before	Prior to March 31, 2018
AE1	April 1, 2018 through September 30, 2018
AE2	October 1, 2018 through March 31, 2019
AF1	April 1, 2019 through September 30, 2019
AF2	October 1, 2019 through March 31, 2020
AG1	April 1, 2020 through September 30, 2020
AG2	October 1, 2020 through March 31, 2021
AH1	April 1, 2021 through September 30, 2021

I.2 Transition Cycle Overview

Prior to the Transition Date, PJM will process all existing AD2 and prior queue projects under the Tariff, Parts IV and VI. Following the Transition Date, PJM will adopt a sorting mechanism whereby projects that require minimal Network Upgrades will be subject to PJM’s expedited process, while placing other projects in Transition Cycle #1, Transition Cycle #2 or the new Cycles. Priority for projects in the Transition Cycle process is determined by the specific Transition Cycle in which a project’s valid New Service Request was placed.

As of the Transition Date, valid AE1-AG1 projects, other than Upgrade Requests, that have not been tendered, or have not executed a final ISA or WMPA will have to satisfy the eligibility and readiness requirements specified in the Tariff and set forth below. Such projects that have demonstrated readiness and met additional eligibility requirements may be able to advance using the expedited process (“fast lane”). Pending AE1-AG1 projects that do not meet the eligibility requirements for expedited processing will be processed in Transition Cycle #1.

Note:

Upgrade Requests will not be subject to the eligibility and readiness requirements. Upgrade Requests in AE1-AG1 will automatically move into the expedited process.

Transition Cycle #1 will include re-prioritized AE1, AE2, AF1, AF2 and AG1 projects and will consist of the following elements: Phase I, Decision Point I, Phase II, Decision Point II, Phase III, Decision Point III, and the Final Agreement Negotiation Phase.

Transition Cycle #2 will include re-prioritized AG2 and AH1 projects and will consist of the following: the Application Phase, Phase I, Decision Point I, Phase II, Decision Point II, Phase III, Decision Point III, and the Final Agreement Negotiation Phase. It will also include Upgrade Customers with Valid Upgrade Requests submitted during the AG2 and AH1 queue windows.

The following diagram is an overview of the Transition Process, which is further detailed in the sections below. See Appendix A for a detailed version of the diagram.

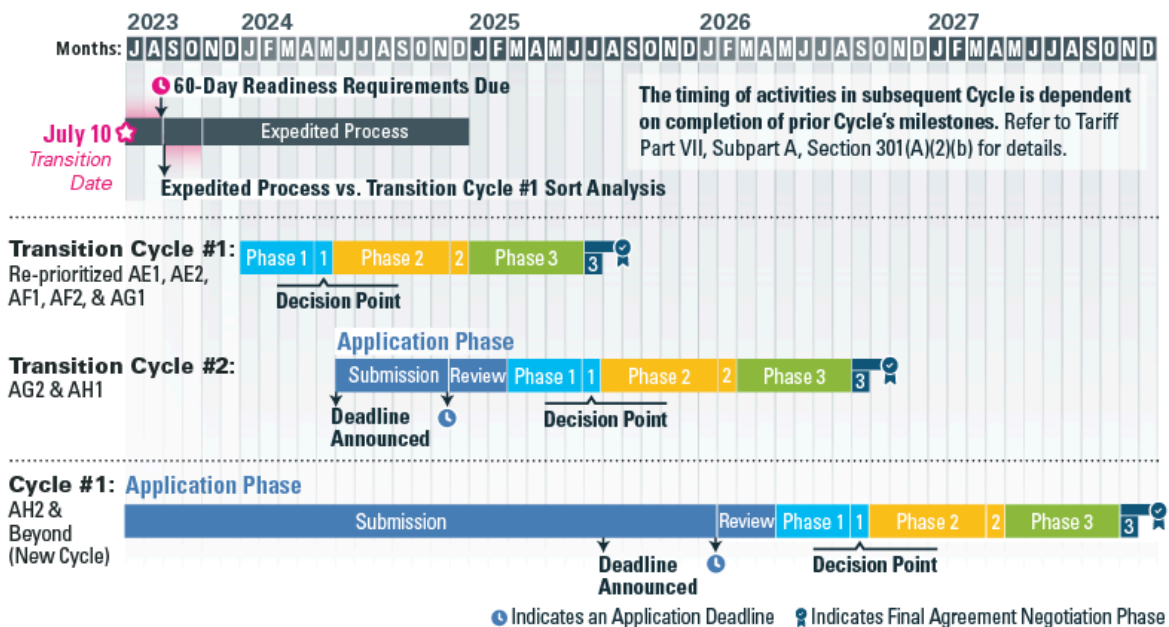

Exhibit 39: Transition Process Overview Diagram

I.2.2 No Block-Out Periods under the Transition Period or New Rules

During the implementation of the Transition Period Rules, there are no block-out periods i.e., no periods in which applications will not be accepted. When PJM provides the notice of the Transition Date that it will begin accepting applications for the first wholly new Cycle, applicants will need to ensure any New Service Requests meet the requirements of Tariff Part VIII.

I.3 Transition Period Rules

I.3.1 Transition Eligibility

Within 60 calendar days after the Transition Date, a Project Developer or Eligible Customer that submitted a valid Interconnection Request to PJM during the period April 1, 2018 through September 30, 2020 (the AE1 through AG1 New Services Queues), that has not been tendered an ISA or WMPA, and whose New Service Request has not been withdrawn will have to demonstrate readiness by:

1. Providing a Readiness Deposit of \$4,000 per MW:
 - The payment can be either by wire transfer or posting of a letter of credit.
 - Any Readiness Deposit provided, in whatever form, must include the Project Identifier (queue number), conspicuously marked.

Note:

If a Project Developer intends to provide the Readiness Deposit using a Letter of Credit, a draft Letter of Credit (that is not executed) must be submitted within 30 days of the Transition Date, in order for PJM to approve the form and language of the draft prior to the Project Developer formally submitting the Letter of Credit (LOC). The draft LOC must be completed using the template language available on the PJM website.

2. Demonstrating Site Control over the Site for the purpose of constructing a Generating Facility or Merchant Transmission Facility:

- Site Control evidence may be through a (1) deed; (2) lease; (3) option to lease or purchase; or (4) any other contractual or legal right to possess, occupy and control the Site deemed acceptable by PJM.
- In the case of an application for a Generating Facility, Site Control must be for 100 percent of the Generating Facility Site, including the location of the high-voltage side of the Generating Facility's main power transformer(s) for at least a one-year term beginning from the Transition Date.
- In the case of an application for a Merchant Transmission Facility, Site Control must be for 100 percent of the land needed for transmission substation facilities (e.g. the location of the high-voltage, direct current converter station(s), phase angle regulator, and/or variable frequency transformer, as applicable, for at least a one-year term beginning from the Transition Date.
- Site Control evidence must comply with the requirements in Tariff, Part VII, Subpart A, section 302.
- Site Control must meet the acreage requirements in the table below:

Fuel Type	Requirement
-----------	-------------

Solar	5 acres per MW
Wind	30 acres per MW
Battery Storage	1 acre per 100MWh
Synchronous Generator	10 acres per facility

Note:

If PJM finds the acreage deficient, a Professional Engineer (PE) stamped Site plan drawing (licensed in the state of the facility location) that depicts the proposed generation arrangement and specifies the Maximum Facility Output for that arrangement will be accepted.

There are no project reduction Tariff provisions available during the readiness submittal review period. In the event that Site control evidence does not meet the acreage requirements specified above and the Project Developer is unable to provide a PE stamped drawing, the project will be terminated and withdrawn.

The documents to satisfy the readiness requirements must be submitted via the queue point tool available on the PJM website.

If a Project Developer fails to satisfy the requirements above, its New Service Request will be terminated and withdrawn.

1.3.2 Readiness Submittals Review

For Project Developers that submit the readiness requirements, PJM will review the submittals beginning the first Business Day following the end of the 60 day submittal window. PJM may request additional clarifying information on the Site Control or Readiness Deposit submittals. In the event that PJM requests additional information, the Project Developer must provide a response within 5 Business Days of PJM sending such a request. If a Project Developer fails to provide a satisfactory response to PJM’s request for additional information within 5 Business Days, its New Service Request will be terminated and withdrawn.

The New Service Request of a Project Developer that provides a satisfactory response to PJM’s request for additional information will continue forward in the process.

1.3.3 Expedited Process Eligibility

After PJM completes the readiness submittal review, Project Developers who have met the readiness requirements specified above will be notified that they will be re-studied to determine shared Network Upgrades impacts.

PJM will use Reasonable Efforts to communicate the estimated timeframe to complete these re-studies within 90 days of the Transition Date. These projects will be studied using an updated version of the base case model that was used for their System Impact Study analysis prior to the effective date of Tariff Part VII.

A New Service Request is not eligible for the expedited process if it has cost allocation eligibility for, or is identified as the first to cause, as determined according to Tariff, Part VI, section 217.3, a Network Upgrade that has a total estimated cost of greater than \$5,000,000. The cost estimate for each Network Upgrade will be based on PJM's most recently available data.

New Service Requests in queue windows AE1 through AG1 that meet the following criteria will be processed pursuant to the Transition Period Rules' expedited process:

1. Have not been tendered, or have not executed, a final ISA or WMPA; and
2. Have met the requirements for the restudy; and
3. The restudy has identified no Network Upgrade requirements or no cost allocation for shared Network Upgrade(s) whose total cost is greater than \$5 million.

New Service Requests submitted in the AE1 through AG1 queue windows that do not meet the expedited process eligibility criteria will be reprioritized to Transition Cycle #1.

The cost associated with the following factors are not considered as part of the analysis to determine expedited process eligibility:

1. Costs associated with Interconnection Facilities required to interconnect the Project Developer's New Service Request;
2. Costs associated with approved baseline or supplemental projects as determined in accordance with the Regional Transmission Expansion Plan.
3. Costs associated with Affected System impacts.

After the re-study is completed, PJM will notify Project Developers and will provide instructions on how to access the results.

I.3.4 Expedited Process Rules

Projects that are eligible for the expedited process will be subject to the following rules:

1. No additional Readiness Deposits or other readiness requirements will apply to expedited process projects. Readiness Deposit provided during the readiness posting period will not be at risk for any project that remains in the expedited process.
2. If a project is an uprate (project relies on the Interconnection Facilities of a prior project) the base project must also qualify for the expedited process in order for the uprate to be included in the expedited process.

3. If a short circuit, stability analysis or a sag study is completed during the expedited process, and it is determined that a reinforcement project is required that has an estimated Network Upgrade cost greater than \$5,000,000, the project will be removed from the expedited process and shifted to Transition Cycle #1.
4. If it is determined during the Facilities Study that the cost of a Network Upgrade is now estimated to be greater than \$5,000,000, the project will be removed from the expedited process and shifted to Transition Cycle #1.
5. Projects in the expedited process will have their Facilities Studies completed, and will be tendered an interconnection-related service agreement pursuant to Tariff, Part IX.

Note:

No changes or modifications to a New Service Request will be permitted after the Transition Date for projects in the expedited process.

I.3.5 Expedited Process Final Agreement Negotiation

PJM will use Reasonable Efforts to complete the Final Agreement Negotiation within 60 days.

The Final Agreement Negotiation procedures for projects that are eligible for the expedited process are summarized below:

1. Upon completion of all required studies for the Interconnection Request, PJM will tender draft final interconnection-related agreement and Facilities Study Report to the Transmission Owner and Project Developer.
2. Project Developer and Transmission Owner shall provide comments no later than 20 Business Days after PJM tenders draft agreements.
3. PJM will use Reasonable Efforts to incorporate Transmission Owner and Project Developer feedback within 10 Business Days of receiving comments and tender the agreements to all parties.
4. No later than 15 Business Days after PJM tenders for execution such agreement, Project Developer shall either execute the agreement, request dispute resolution or request in writing that the agreement be filed unexecuted and provide the required Security.
5. No later than 15 Business Days after PJM sends notification to the relevant Transmission Owner that the Project Developer has executed the agreement, Transmission Owner shall either execute the agreement, request in writing dispute resolution or request in writing that the agreement be filed unexecuted.
6. Following execution by Transmission Owner PJM shall either execute the agreement, request in writing dispute resolution or request in writing that the agreement be filed unexecuted. PJM may also file the agreement with FERC in unexecuted form if Transmission Owner does not comply with the requirements above. With the filing of any unexecuted agreement, PJM may, in its discretion, propose to FERC a resolution of any or all of the issues in dispute between the parties.

The following shall also apply to projects eligible for the expedited process:

- If electing Option to Build for Stand Alone Network Upgrades, written notification from the Project Developer must be received within 30 days of receipt of the draft interconnection-related agreement and Facilities Study. Project Developer may not elect Option to Build after the 30 day deadline.
- If multiple projects receive cost allocation for a Network Upgrade, the cost allocation for each Network Upgrade will be captured in the GIA Security calculation for each project. NUCRAs will not be issued for projects in the expedited process.

I.4 AE1-AG1 Transition Cycle 1

AE1-AG1 projects that have met the readiness requirements but were not eligible for expedited processing will be processed in Transition Cycle #1.

An overview of Transition Cycle #1 is provided in the diagram below.

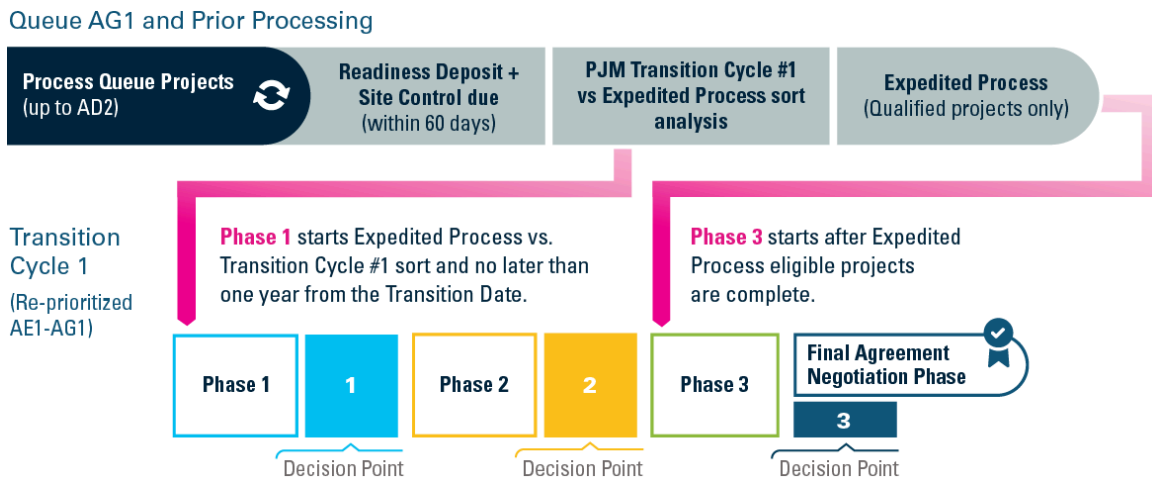

Exhibit 40: Transition Cycle #1 Diagram

I.4.1 Timing of Transition Cycle #1

Phase I of Transition Cycle #1 will start after PJM completes the eligibility review for the expedited process and no later than one year from the Transition Date.

Transition Cycle #1 will run concurrently with the expedited process.

Phase III of Transition Cycle #1 will not start until after all valid projects in the expedited process have executed their relevant interconnection-related agreement. The applicable forms of agreement are set forth in Tariff, Part IX.

PJM will make the Transition Cycle #1 load flow model available to Project Developers 30 days prior to the start of Phase I, subject to Critical Energy Infrastructure Information requirements.

I.4.2 Application Requirements

There is no requirement in Transition Cycle #1 to complete the application contained in Tariff, Part IX, and there is no Application Review Phase in Transition Cycle #1. PJM will proceed with the required studies using the latest System Impact Study data available for each New Service Request.

I.4.3 Deposits

Required study and Readiness Deposits will be as detailed in section 6 of this manual.

A Study Deposit is not required with the Readiness Deposit payment within 60 days of the Transition Date. However, additional Study Deposits may be requested from the Project Developer, if remaining Study Deposits are not sufficient to cover the estimated costs of the interconnection studies. Project Developers are responsible for, and must pay, all actual study costs. If PJM sends Project Developer or notification of additional study costs, then the Project Developer must either (i) pay all additional study costs within 20 Business Days of Transmission Provider sending the notification of such additional study costs or (ii) withdraw its New Service Request. If the Project Developer does not complete (i) or (ii), its project will be withdrawn and terminated.

I.4.4 Modifications

No changes or modifications to a New Service Request will be permitted after the Transition Date until Transition Cycle #1 Decision Points I and II in accordance with Tariff Part VII.

I.5 AG2-AH1 Transition Cycle 2

I.5.1 Overview

Each valid New Service Request from AG2-AH1 will be assigned to Transition Cycle #2.

An overview of the Transition Cycle #2 process is provided in the diagram below.

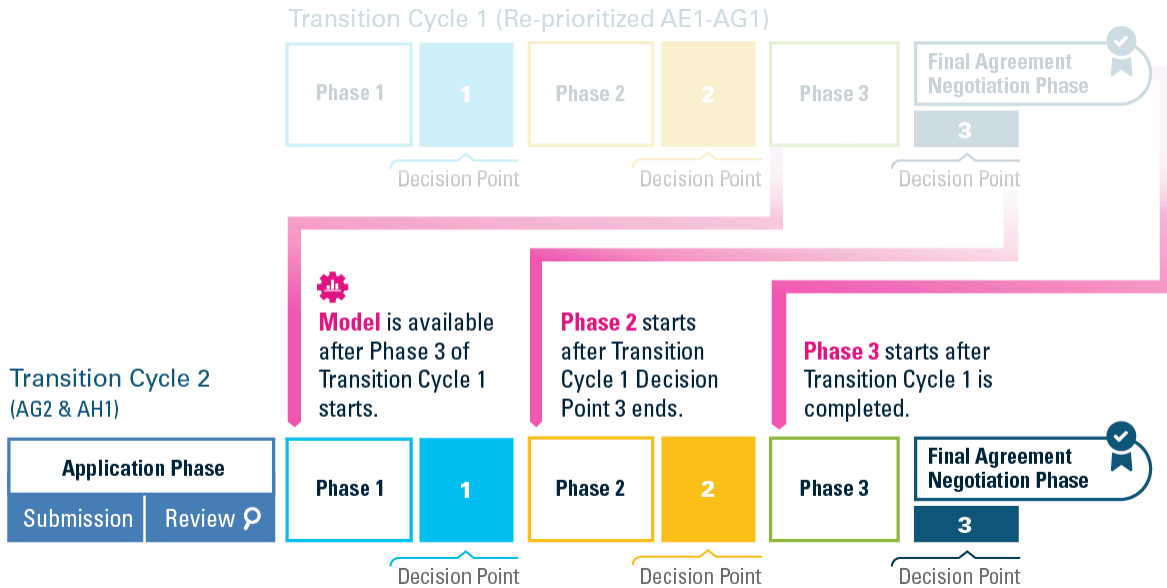

Exhibit 41: Transition Cycle #2 Diagram

I.5.2 Timing of Transition Cycle No. 2

PJM will announce the Transition Cycle #2 Application Deadline at least 180 days prior to the Application Deadline.

Phase I of Transition Cycle #2 will only start after:

1. all application review period activities have been completed for that Cycle; and
2. the Phase I Base Case data has been made available for a 30 day review during the Application Phase of that Cycle. Phase 1 Base Case data will be available after Decision Point II of Transition Cycle #1 has concluded.

PJM will use Reasonable Efforts to complete Phase I within 120 calendar days of the start of Phase II, or on the next Business Day thereafter, if the 120th calendar day does not fall on a Business Day.

Phase II of Transition Cycle #2 will start on the first Business Day immediately following the end of the Decision Point I unless Decision Point III of Transition Cycle #1 is still open. In no event will Phase II start before the conclusion of Transition Cycle # 1 Decision Point III.

PJM will use Reasonable Efforts to complete Phase II within 180 calendar days of the start of Phase II, or on the next Business Day thereafter, if the 180th calendar day does not fall on a Business Day.

Phase III of Transition Cycle #2 will start on the first Business Day following the end of Decision Point II unless the Final Agreement Negotiation Phase of Transition Cycle #1 is still open. In no event shall Phase III commence before the Final Agreement Negotiation Phase of Transition Cycle #1 has concluded (with all New Service Requests within Transition Cycle #1 either being withdrawn or resulting in a fully executed Tariff, Part IX service agreement).

PJM will use Reasonable Efforts to complete Phase III within 180 calendar days of the start of Phase III, or on the next Business Day thereafter, if the 180th calendar day does not fall on a Business Day.

I.5.3 Application Requirements

The application requirements are summarized below. Application submissions will be made electronically following the guidance within the PJM application submission tool.

Application Requirements for Project Developers or Eligible Customers

To move forward in Transition Cycle #2, each Project Developer or Eligible Customer with valid projects in AG2 through AH1 must submit an application in the form provided in Tariff, Part IX, Subpart A and submit the required Study Deposit amounts and a Readiness Payment by the Application Deadline, as outlined in Tariff, Part VII, Subpart C, section 306, Application Rules.

Application Requirements for Upgrade Customers

To move forward in Transition Cycle #2, each Upgrade Customer with a valid project in AG2 and AH1 must submit an Upgrade Application and Studies Agreement (UASA) with revised technical data and/or configuration information and submit the required Study Deposit amounts, as set forth in Tariff, Part VII, Subpart H, section 337, Upgrade Requests.

Each Upgrade Request from AG2-AH1 will maintain its existing priority relative to other AG2-AH1 Upgrade Requests upon successful resubmission under Tariff, Part VII, Subpart H, section 337 Upgrade Requests. The priority for AG2 and AH1 Upgrade Requests is subsequent to valid AG1 and prior requests.

I.5.4 Deposits

Required study and Readiness Deposits will be as detailed in section 2 and section 6 of this Manual.

During the Application Phase, existing unspent Study Deposits will be taken into account.

I.5.5 Modifications

The following modification restrictions apply to application submissions in Transition Cycle #2. No changes will be accepted prior to Transition Cycle #2 application submission.

1. The fuel type cannot change from that which was previously submitted for the valid projects in AG2 through AH1; and
2. Maximum Facility Output and/or Capacity Interconnection Rights values cannot be increased but may be reduced up to 100 percent from that which was previously submitted for the valid projects in AG2 through AH1; and
3. the Project Developer must choose between the primary or secondary Point of Interconnection as previously identified in its New Service Request from that which was previously submitted for the valid projects in AG2 through AH1; and
4. Eligible Customer transmission capacity requested for each Point of Receipt and each Point of Delivery on the Transmission System cannot increase but may be reduced up to 100 percent from that which was previously submitted for the valid projects in AG2 through AH1.

Additional modifications will only be permitted at Transition Cycle II Decision Points I and II in accordance with Tariff Part VII.

I.6 Transition Cycle Phases and Decision Points

I.6.1 Application Phase

This is the Cycle period that includes both the submission and review of New Service Requests. The Project Developer or Eligible Customer submits an application during this Phase and PJM validates the submission and assigns a Project Identifier as summarized in Tariff Part VII. Application Phase is only applicable to Transition Cycle #2.

I.6.2 Phase I, Phase II and Phase III

An overview of the activities performed in each System Impact Study phase is summarized below and further described in Tariff Part VII. Refer to Section 2, 4 and 5 of this Manual for additional information.

Item	Phase I	Phase II	Phase III
Duration	120 Calendar Days (Reasonable Efforts)	180 Calendar Days (Reasonable Efforts)	180 Calendar Days (Reasonable Efforts)
Analysis	Summer Peak load flow analysis Light Load load flow Analysis	Retool load flow results Short circuit study Stability analysis Initial Affected System study results (if needed)	Final retool of all Phase II analyses Final Affected System study (if needed)

	For New Service Request in Transition Cycle #2 and beyond only: Winter load flow analysis (applicable).	PJM will notify Project Developer or Eligible Customer of requirement to enter into an Affected System Study Agreement (if needed)	
Transmission Owner Interconnection Facilities	Transmission Owner provides planning desk-side estimate - Scope, cost, schedule	Transmission Owner performs Facilities study and provides Scope, cost, schedule – Facilities Study level estimate	Project Developer or Eligible Customer provides target backfeed date
Network Upgrades	Transmission Owner provides Scope, cost, schedule – planning desk-side estimate PJM provides cost allocation	Transmission Owner provides Scope, cost, schedule – planning desk-side estimate PJM provides cost allocation	Transmission Owner performs Facilities study for Network Upgrades PJM provides final cost allocation
Final Agreement Related Items	For projects accelerating to final agreements: PJM will draft final agreements, calculate security as applicable and tender at the close of the phase.	For projects accelerating to final agreements: PJM will draft final agreements, calculate security as applicable and tender at the close of the phase.	PJM will draft final agreements, calculate security as applicable and tender at the close of the phase.

Exhibit 42: Cycle Phase I, Phase II, Phase III Overview

Study results will be provided as a single Cycle format on the PJM website. Project Developers will no longer be emailed individual results and will need to obtain the results from the website.

PJM will use Reasonable Efforts to complete the phase within the duration specified above or notify the project Developer or Eligible Customer of the estimated time to complete the phase in accordance with Tariff Part VII. If the last day of the applicable phase time period does not fall on a Business Day, such last day will fall on the next Business Day.

I.6.3 Decision Points

During each Decision Point following PJM’s posting of the System Impact Study results, a Project Developer or Eligible Customer will have a thirty calendar day window to provide any required information and deposit to proceed to the next phase, modify request as applicable or withdraw. If the thirtieth calendar day does not fall on a Business Day, the Project Developer or Eligible Customer shall have until the next Business Day to meet these requirements. All New Service Requests must comply with the Decision Point requirements outlined in Tariff Part VII, Subpart D, sections 309, 311 and 313.

I.6.4 Final Agreement Negotiation Phase

During the Final Agreement Negotiation Phase, PJM will negotiate the terms of the final agreement with the parties to the agreements. The final agreement Negotiation Phase for each cycle will follow the procedures outlined in Tariff Part VII, Subpart D, section 314. PJM will use Reasonable Efforts to complete this phase within 60 days from the close of Phase III.

I.7 Site Control Requirements

Project Developers must provide evidence of Site Control at various points in a Cycle. Site Control submissions must comply with the requirements in Tariff, Part VII, Subpart A, section 302 and 303, Subpart B, section 303, Subpart C, section 306, and Subpart D, sections 309, 311, and section 313. Refer to Section 2 and Section 7 of this Manual for additional information.

Site Control term requirements are summarized below:

		Site Control Term		
		Generating Facility	Interconnection Facility	Interconnection Switchyard
Submission 1 Application Phase	Full	100% Deed Lease Option (See Note 1)	Not Required	Not Required
Term Requirement		1 year from Application Deadline		
Submission 2 Decision Point 1 (See Note 2)	Partial	100% Deed Lease Option	50% Deed Lease Option Right-of-Way	50% Deed Lease Option
Term Requirement		1 year from last day of Phase 1		
Submission 3 Decision Point 3 (See Note 3)	Full	100% Deed Lease Option	100% Deed Lease Option Right-of-Way	100% Deed Lease Option (See Note 4)
Term Requirement		Additional 1 year from last day of Phase 3		



 = 100% Site Control Required
  = 50% Site Control Required

Exhibit 43: Site Control Requirements

The following notes apply to the Site Control term requirements:

Note 1: Merchant Transmission projects need to demonstrate 100% Site Control for Transmission Substation Facility (e.g. HVDC converter station, phase angle regulator (PAR), and/or variable frequency transformer (VFT)) up front in Application Phase. (The Transmission line not included).

Note 2: Jurisdictional projects that are eligible for an accelerated process to receive their final interconnection-related agreement at DPI or DPII will be required to provide full Site Control for an additional one-year term from the last day of Phase I or Phase II, respectively.

For a non-jurisdictional project, the Project Developer must provide such evidence for a one-year term beginning from last day of the relevant Cycle Phase that extends through full execution date of the relevant state level interconnection agreement with the applicable entity, plus one year beyond such full execution date of the relevant state level interconnection agreement with the applicable entity.

If Project Developer fails to produce all required Site Control evidence at the time it is accelerated, it must show concrete evidence acceptable to PJM that it is in negotiations to achieve 100% of all required Site Control, and PJM will add a condition precedent to the final interconnection-related agreement requiring that such Site Control be achieved within 180 days of the effective date of the interconnection-related agreement.

If 100% Site Control is not obtained within 180 days of the effective date of the final interconnection-related agreement, then the project will automatically be deemed terminated and will be withdrawn from the Cycle.

Note 3: If 100% Site Control is not obtained by Decision Point III, then Project Developer must show concrete evidence acceptable to PJM that it is in negotiations to achieve 100% of all required Site Control for a period of at least one year from the last day of Phase III, and PJM will add a condition precedent to the final interconnection-related agreement requiring that within 180 days of the effective date of such agreement, 100% Site Control be acquired for at least one year from the last day of Phase III.

If 100% Site Control is not obtained within 180 days of the effective date of the final interconnection-related agreement, then the project will automatically be deemed terminated and will be withdrawn from the Cycle.

Note 4: Project Developer will need to be in compliance with Interconnection Transmission Owner's ultimate ownership requirements for the Interconnection Switchyard.

I.8 Deposits

Refer to section 2 and section 6 of this Manual for information on Study and Readiness Deposits.

I.9 Additional Information Applicable to All Request Types

I.9.1 Non-FERC Jurisdictional Interconnections:

If a Project Developer is proposing a Generating Facility that will physically connect to non-jurisdictional distribution or sub-transmission facilities and intends to participate in wholesale sales in the PJM markets, the Project Developer must provide additional required information and documentation associated with the non-jurisdictional arrangements, as outlined in Tariff, Part VII, Subpart D, sections 309, 311 and 313 and Tariff, Part IX, Subpart C.

I.9.2 Swapping New Service Requests

A Project Developer or Eligible Customer cannot combine, swap or exchange all or part of a New Service Request with any other New Service Request within the same or a different Cycle.

I.9.3 Assigning New Service Requests

Before entering into a final agreement from Tariff, Part IX, a Project Developer or Eligible Customer may assign its New Service Request to another entity only if the acquiring entity:

- as applicable, accepts and acquires the rights to the same Point of Interconnection and Point of Change of Ownership as identified in the New Service Request for the project;
- and/or as applicable, accepts, as applicable, the same receipt and delivery points or the same source and sink points as stated in the New Service Request for such project.

Appendix A – Transition Process Overview Diagram

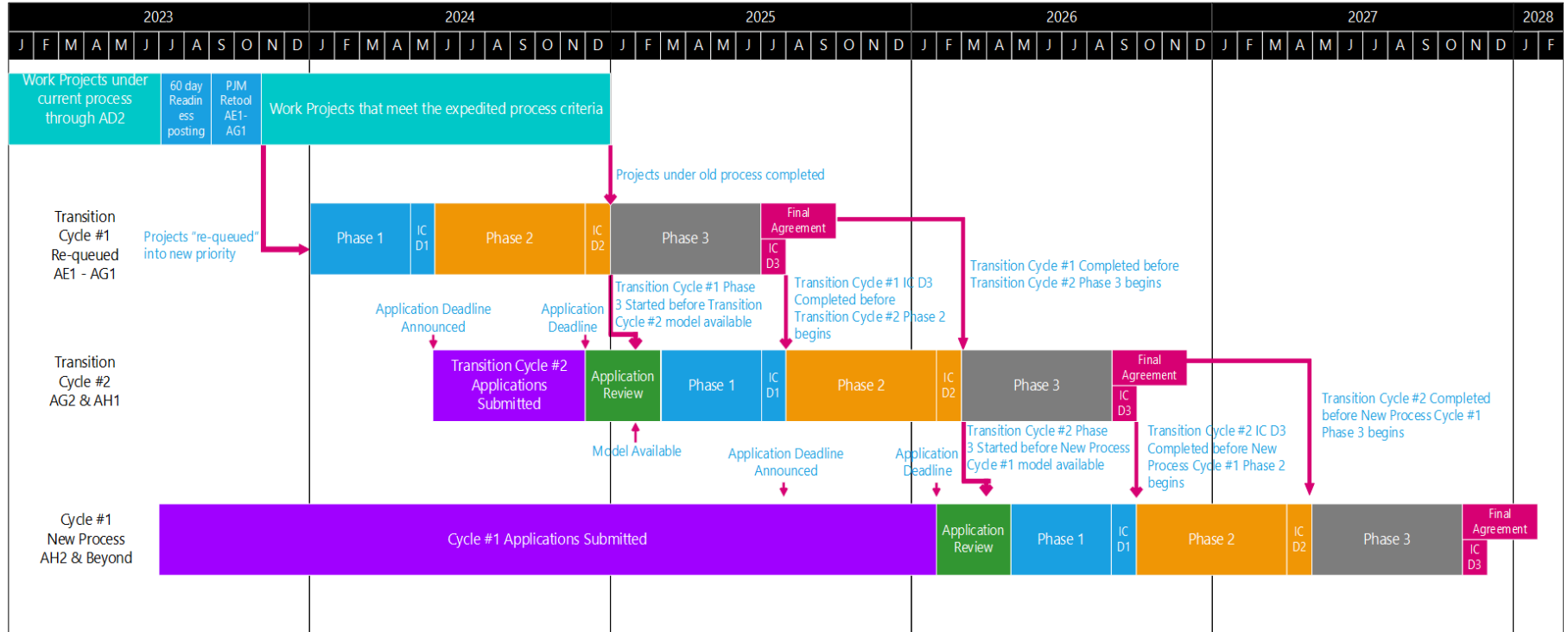

Attachment J: Site Plan Requirements

Attachment J provides examples of Site plans for Interconnection Requests.

J.1 Generation Interconnection Requests Site Plan

The examples below represent Site plans for Generation Interconnection Requests.

J.1.1 Multiple Requests on One Site

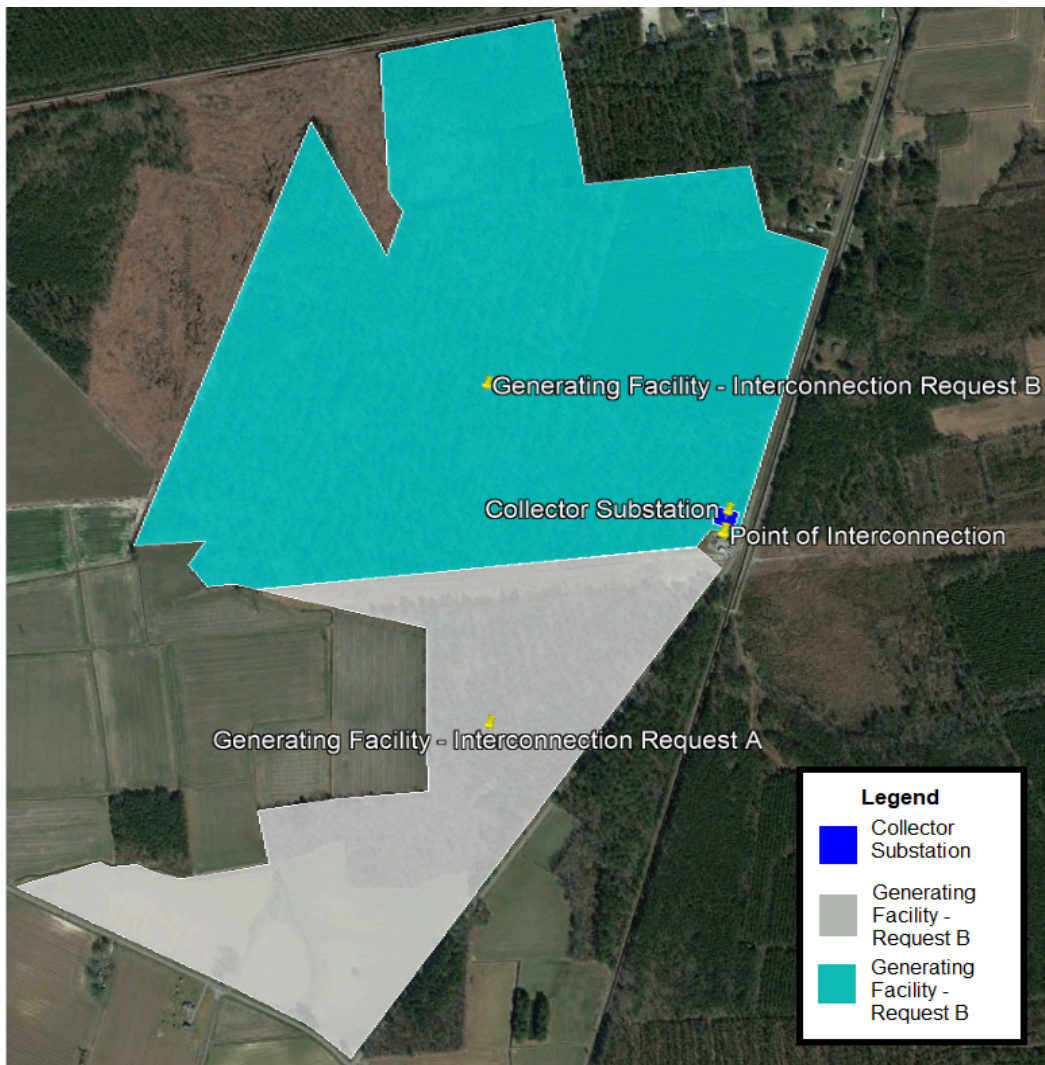

Exhibit 44: Site with Multiple Requests

Exhibit (Site with Multiple Requests) is an example of using one Site for multiple requests. In this scenario, the Site plan must show all requests and the proposed space utilization. If the provided acreage is not sufficient per Manual 14H requirements, a Professional Engineer (PE) stamped drawing, in the state of the Generating Facility, is required that depicts the proposed generation arrangement and the MFO to demonstrate that the Site can support the density of all proposed Interconnection Requests.

J.1.2 Addition of Non-Contiguous Parcels to Site

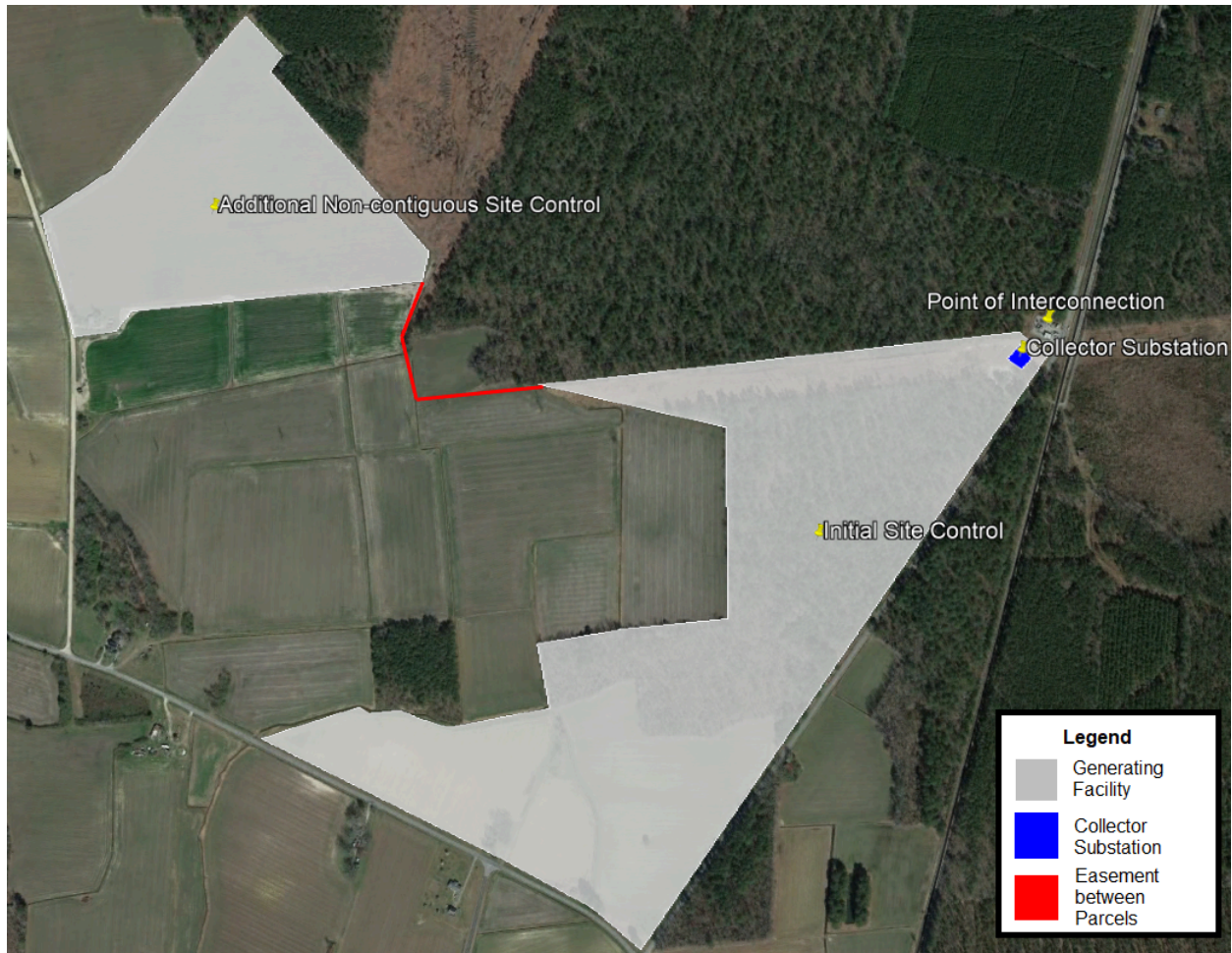

Exhibit 45: Adding Non-contiguous Parcels to Site

Exhibit (Adding Non-contiguous Parcels to Site) represents the scenario where a Project Developer changes the Site Control at Decision Point I or Decision Point II and adds a non-contiguous (not adjacent) parcel. Evidence of easement between the added parcel and the originally provided Site is required.

J.1.3 Interconnecting into an Existing Substation



Exhibit 46: Interconnecting into an Existing Substation

Exhibit (Interconnecting into an Existing Substation) represents a Generation Interconnection Request with a generator lead line interconnecting into an existing substation. Evidence of partial (50%) Site Control for the Interconnection Facilities is required at Decision Point I and evidence of full (100%) Site Control is required at Decision Point III.

J.1.4 Tapping a Transmission Line through the Site



Exhibit 47: Tapping an Existing Transmission Line

Exhibit (Tapping an Existing Transmission Line) represents a Generator Interconnection Request tapping a transmission line that passes through the Project Developer's Site.

J.2 Transmission Interconnection Request Site Plan

The example below represent Site plans for a Transmission Interconnection Request.

J.2.1 Merchant Transmission Request Site Plan

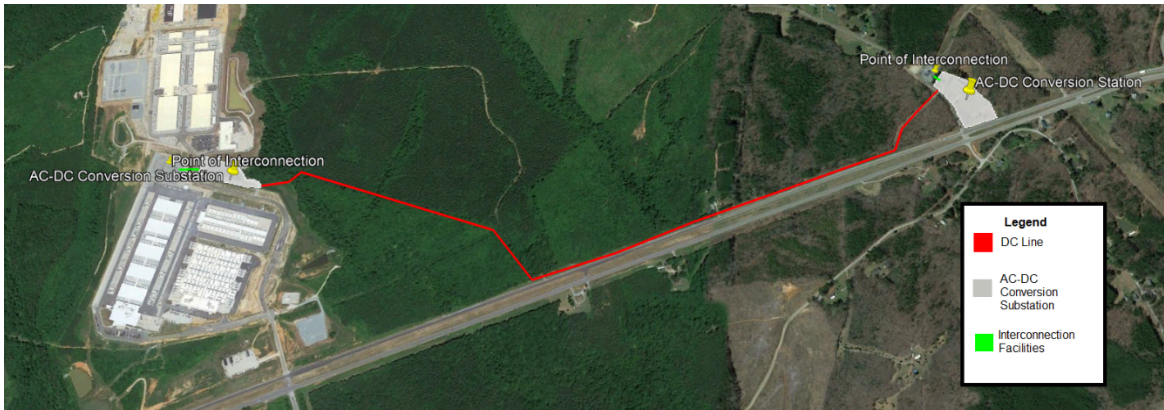

Exhibit 48: Merchant Transmission Request Site Plan

Exhibit (Merchant Transmission Request Site Plan) represents a typical DC line with an AC/DC conversion on each end of the line.

At the Application Phase, evidence of Site Control is required for the transmission substation facilities. In this case, the transmission substation facilities would be the AC/DC conversion substations.

At Decision Point III, full (100%) Site Control is required for all facilities in the diagram including the Merchant Transmission Facilities Site, Interconnection Facilities (to the Point of Interconnection(s)) and the transmission line.

Revision History

Revision 02 (07/23/2025):

- Conforming changes with FERC Docket Numbers EL25-22-000 and ER25-1544-000:
 - Section 7.2.1
 - Section 7.2.2
 - Section 7.2.3
 - Section 7.2.4
 - Section 7.2.5

Revision 01 (03/19/2025):

- Changed Manual Ownership from Jaseon Shoemaker to Andrew Lambert

Conforming changes to Surplus Interconnection Service OATT changes per FERC Docket No. ER25-778:

- Section 1.2.5 - Changes to allow Project Developers to apply for Surplus Interconnection Service from planned as well as existing generating facilities.
- Section 12
 - Eliminate restrictions on Surplus service when:
 1. the service would affect the determination of Network Upgrades for projects already in the interconnection process, or
 2. result in material adverse impacts on short circuit capability limits, steady-state thermal and voltage limits, or dynamic system stability and response.
 - Changes to allow Project Developers to apply for Surplus Interconnection Service from planned as well as existing generating facilities.
 - Changes to permit Surplus Interconnection Service even in circumstances in which additional physical interconnection facilities are needed to accommodate that service.
 - Clarifying edits and corrections.

Revision 00 (07/26/2023):

- This is a new Manual